

ZANUSSI

BUILT-IN ELECTRIC

MULTIFUNCTION

DOUBLE OVEN

ZDQ 895

INSTRUCTION BOOKLET

TECHNICAL DETAILS

MODEL NO. ZDQ 895

Wattage: 5.0/5.5kW

Height: 897 mm

Width: 592 mm

Depth: 563 mm
(excluding handles and knobs)

Weight: 55kg

 This appliance complies with: European Council Directive 73/23/EEC.
ECM Directive 89/336/EEC.
CE Marking Directive 93/68/EEC.

CONTENTS

Technical Details	2
Contents	3
Safety	5
Before Installation	5
During Operation	5
After Use	6
General	6
Installation Instructions	7
Things You Need to Know	7
Warnings	7
Things to Note	7
Getting Things Ready	7
Choice of Electrical Connection	7
Preparing Cabinet for Fitting Oven	7
Recommended Cabinet Dimensions	8
How to Finish Unpacking	9
Tools Required	9
Making the Electrical Connections	9
Preparing Cable	9
To Remove Cover of Mains Terminal	9
Connecting to the Mains Terminal	10
Connecting to a Hob or Cooker Point	10
Checking Electrical Connections	10
Fitting Into The Cabinet	11
Introduction	12
When First Switching On	12
Rating Plate	13
General Notes on Using the Ovens	13
About Condensation and Steam	13
Cookware	13
The Cooling Fan for the Controls	13
Control Panel Indicator Neons	13
On/Off Push Button	13
Oven Function Control Push Button	13
Increase and Decrease Push Button	13
Grill and Oven Furniture	14
Electronic Oven Control	15
How to Select Main Oven Cooking Functions and Temperature	19
To Fit the Main Oven Shelves	19
Cooking Functions	19
Boost Function and Pizza Oven Function	20
Uses of Boost Function	20
Selecting Boost Function	20
Uses of Pizza Oven Function	20
Selecting Pizza Oven Function	20
Things to Note	20
Hints and Tips	20
The Main Oven Fan Cooking	21
Uses of the Fan Oven	21
Selecting the Fan Oven	21
Things to Note	21
Hints and Tips	22
The Main Oven - Conventional Setting	23
Uses of the Conventional Oven	23
Selecting the Conventional Oven	23
Things to Note	23

CONTENTS

Oven Cooking Chart	24
Roasting Chart	25
Thermal Fan Assisted Grilling	26
Uses of Thermal Fan Assisted Grilling	26
Selecting Thermal Grilling	26
Things to Note	26
Hints and Tips	27
Thermal Fan Assisted Grilling Chart	27
The Main Oven - Grill	28
Selecting the Main Oven - Single Grill	28
Things to Note	28
Using Telescopic Runners (Where Fitted)	28
Grill Pan and Handle	29
Hints and Tips	29
Grilling Chart	30
Bottom Heat	31
Uses of the Bottom Heat Function	31
Selecting the Bottom Heat Function	31
The Effects of Dishes on Cooking Results	31
Defrost Feature	32
Uses of Defrost Feature	32
Selecting Defrost.....	32
Things to Note	32
Hints and Tips	32
Main Oven Light	33
Selecting the Main Oven Light	33
Safety and Energy Saving Functions	33
The Top Oven	34
Uses of the Top Oven	34
Selecting the Top Oven	34
Things to Note	35
To Fit the Top Oven Shelf	35
Using Telescopic Runners (Where Fitted)	35
Hints and tips	36
The Top Oven Cooking Chart	37
The Top Oven Grill	38
Uses of Top Oven Grill	38
Selecting Top Oven Grill	38
Things to Note	38
Grill Pan and Handle	38
Hints and Tips	39
Top Oven Grilling Chart	39
Care and Cleaning	40
Cleaning Materials	40
Cleaning the Outside of the Appliance	40
Cleaning the Grill/Top Oven Compartment	40
Cleaning the Top Oven Roof	40
Cleaning Inside the Main Oven	41
Care of Stayclean Surfaces	41
Hints and Tips	41
Cleaning the Shelves, Wirework Runners and Grill/Oven Furniture	41
To Remove the Wirework Runners	42
Cleaning Between the Outer and Inner Door Glass.....	42
Replacing the Oven Light Bulb	43
Something Not Working?	44
Service and Spare Parts	45
Guarantee Conditions	46
Notes	47

SAFETY

THESE WARNINGS ARE PROVIDED IN THE INTERESTS OF YOUR SAFETY. ENSURE THAT YOU UNDERSTAND THEM ALL BEFORE INSTALLING OR USING THE APPLIANCE.

PLEASE
READ
CAREFULLY

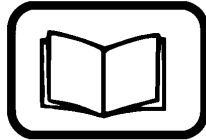

BEFORE INSTALLATION



This appliance is heavy and care **must** be taken when moving it.



Ensure that all packaging, both inside and outside the appliance, has been removed before the appliance is used.



Do not try to *lift* or move the appliance by pulling the door handles. Refer to installation instructions.



The appliance must be installed according to the instructions supplied. All electrical installation work **must** be undertaken by a qualified electrician/competent person.

It is dangerous to alter or modify the specifications of the appliance in any way.



Do not allow young children to play with any part of the packaging.



After installation, please dispose of the packaging with due regard to safety and the environment, your local authority can arrange this.

DURING OPERATION



Do not use this appliance if it is in contact with water. **Never** operate it with wet hands.



This appliance is designed to be operated by adults. Young children **must not** be allowed to tamper with the appliance or play with the controls.

During use the appliance becomes **Hot**. Care should be taken to avoid touching the heating elements inside the oven.

CAUTION: Accessible parts may be hot when the grill is in use. Young children should be kept away.



Take **great care** when heating fats and oils, as they will ignite if they become too hot.

This appliance has been designed for cooking edible foodstuffs only, and **must not** be used for any other purposes.



Never place plastic or any other material which may melt in the oven or on the hob.



Ensure cooking utensils are large enough to contain foods to prevent spillages and boil overs.



Take care to follow the recommendations given for tending the food when grilling.



Always use oven gloves to remove and replace food in the oven. Accessible parts around the oven vents will become hot when the oven is in use.



Ensure that you support the grill pan when it is in the withdrawn or partially withdrawn position.

Ensure that all vents are left unobstructed to ensure ventilation of the oven cavity.



You must ensure that the grill control is in the 'OFF' position when the timer control has been set for automatic cooking.

Ensure the anti-tilt shelves are put in place correctly. Refer to instructions on page 19 and 35.



Never line any part of the appliance with foil. **Do not** allow heatproof cooking material, e.g. roasting bags, to come into contact with oven elements.



Always stand back from the appliance when opening the oven door to allow any build up of steam or heat to release.



Stand clear when opening the drop down oven door. **Do not** allow it to fall open – support it using the door handle, until it is fully open.



Never leave the appliance unattended when the oven doors are open.



Do not place sealed cans or aerosols inside the oven. They may explode if they are heated.

AFTER USE



Ensure that all control knobs are in the OFF position when not in use.



For hygiene and safety reasons this appliance should be kept clean at all times. A build-up of fats or other foodstuffs could result in a fire, especially in the grill pan.



Do not leave utensils containing foodstuffs, e.g. fat or oil in or on the appliance in case it is inadvertently switched on.



Cookers and hobs become **very hot**, and retain their heat for a long period of time after use. Children should be kept well away from the appliance until it has cooled.

GENERAL

Under no circumstances should any repairs be carried out by an inexperienced person as this may cause injury or serious malfunction.



This appliance should be serviced by an authorised Service Engineer and only genuine-approved spare parts should be used. Details of repair and servicing arrangements are supplied on page 45 of this book.



Do not stand on the appliance or on the open oven door.



Do not hang towels, dishcloths or clothes from the appliance or its handle. They are a safety hazard.

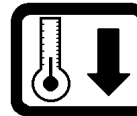

Always allow the cooling fan to cool the appliance down before switching off at the wall prior to carrying out any cleaning or maintenance work.



Only clean this appliance in accordance with the instructions given in this book.

Your safety is of paramount importance.

Therefore, if you are unsure about any of the meanings of these WARNINGS contact the:

**Customer Care Department
Telephone 0870 5 727727**

INSTALLATION INSTRUCTIONS

THINGS YOU NEED TO KNOW

WARNINGS

- This appliance must be installed by a qualified electrician/competent person. Safety may be impaired if installation is not carried out in accordance with these instructions.
- This appliance must be earthed.
- **Do not** remove the screws from the earth tab extending from the oven mains terminal block (Fig. 6).
- Before connecting the appliance make sure that the voltage of your electricity supply is the same as that indicated on the rating plate. This is situated on the lower front frame of the appliance and can be seen upon opening the top cavity door. Alternatively the rating plate may also be found on the back or top of some models (where applicable).
- **Do not** alter the electrical circuitry of this appliance.

THINGS TO NOTE

- This appliance is designed to be fitted in cabinets of the recommended dimensions as shown (Fig. 2).
- If your cabinet interior dimension is between 565-570mm the oven may still be fitted. However a minor modification to the cabinet will be required to reduce the aperture size down to 560-565mm. To allow the product to be securely screwed into the cabinet.
- The dimensions given provide adequate air circulation around the unit within the cabinet, ensuring compliance with BS EN60-335.
- Enquiries regarding the installation of the cooker point, if required, should be made to your Regional Electricity Company to ensure compliance with their regulations.
- The cooker socket switch should be outside the cabinet but within 2m of the appliance to make it accessible to switch off the appliance in case of an emergency.
- To protect the hands, wear gloves when lifting the oven into its housing.

NOTE: HOUSE CIRCUIT

Earth leakage and continuity tests must be carried out before the appliance is connected to the mains supply and re-checked after fitting.

GETTING THINGS READY

CHOICE OF ELECTRICAL CONNECTION

- There are three possible ways to connect your appliance. In each case the appliance should be operated using at least 6mm² twin core and earth PVC insulated multicore cable. Please choose from the most appropriate after reading the different methods:-

- a) By connecting the appliance to a cooker point (having a double pole isolating switch with at least 3mm contact separation in all poles and neutral) and protected with a fuse or miniature circuit breaker at your mains fuse box.

Subject to Regional Electricity Companies regulations if you wish to connect the oven and hob to the power supply you may use one of the following two methods:-

- b) By connecting the appliance together with a hob directly to a cooker point(s). Having a double pole isolating switch with at least 3mm contact separation in all poles and neutral.
- c) If you wish to connect an oven and a hob to a cooker point you can by connecting the oven and hob separately to the cooker point. Oven and hob units should be separately connected to a cooker point. See Fig. 1.

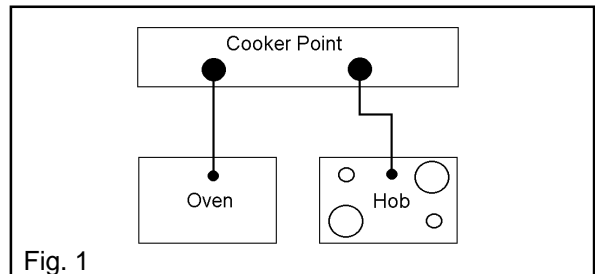

NOTE: It is good practice to :

- Fit an Earth Leakage Circuit Breaker to your house wiring.
- Wire your appliance to the latest IEE regulations.

PREPARING CABINET FOR FITTING OF OVEN

- Make sure that the cabinet is the correct size for the appliance to be fitted (Ref. Fig. 2).
- If the cabinet is between 565-570mm, then the cabinet should be modified so that at the screw fixing points the recommended dimension of at least 560-565mm is maintained. The modification should ideally be localised to ensure that after screw fitment the oven is **securely** fixed into position.
- The cabinet must be stable and level securing it to the wall or floor. If necessary, make arrangements to ensure the shelf upon which the oven will rest is level.
- When the appliance is installed ensure a minimum gap of 2mm is maintained between the trim on the bottom edge of the appliance, and any corresponding door / panel.

RECOMMENDED CABINET DIMENSIONS (IN MILLIMETRES)

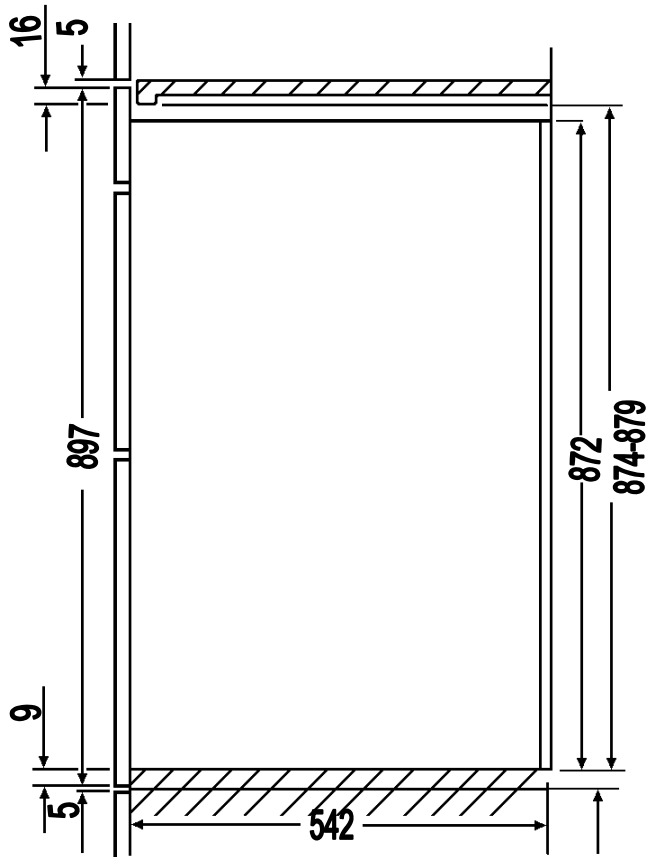
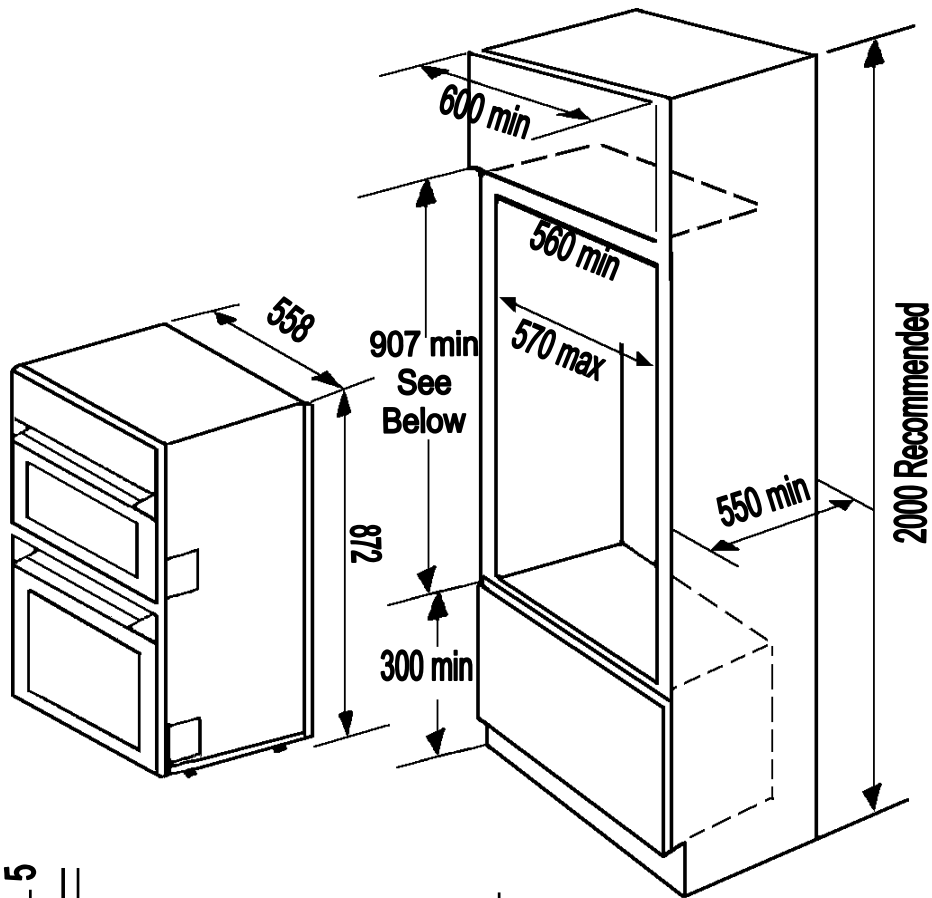

Cross section through cabinet showing oven positioned

Fig. 2 Built In Installation

HOW TO FINISH UNPACKING

- Place appliance next to the cabinet in which it will be installed.
- Remove the appliance packing except for bottom tray which should be left in position until the appliance is ready to be fitted into its cabinet.
- Ensure the owner is given these operating instructions.

TOOLS REQUIRED

The following tools will be needed and it helps to assemble them before starting to install your oven:

- A terminal screwdriver (3mm wide blade)
- A pozidrive screwdriver
- Pliers
- Wirestrippers
- Knife
- Sidecutters
- Adhesive tape
- Tape Measure

MAKE THE ELECTRICAL CONNECTIONS

Important: Switch off at mains, miniature circuit breaker and if appropriate, remove fuse before commencing any electrical work.

PREPARING CABLE

We recommend you use a new length of cable to ensure your safety.

- Ensure you have the correct length of cable appropriate to the wiring method you are using. When fitting new cable allow sufficient cable for removal of the unit at a later date, should it be necessary.
- Score, but **do not** cut through, around the sheathing with a knife 100mm (4in) from each end of the cable and break through to the encased wires by bending the cable backwards and forwards to fatigue the sheathing. Carefully score down from each of the cable sheathing along the length of the bare earth wire (if a cut was made along the length of the live or neutral wires, it might cut into their sheathing) to the cuts already made.
- Carefully prise open the sheathing at each end of the cable to expose the encased wiring.

TO REMOVE COVER OF MAINS TERMINAL

From the rear of the appliance, remove mains input terminal cover to gain access to terminal block.

- First remove retaining screw with pozidrive screwdriver. See Fig. 3.

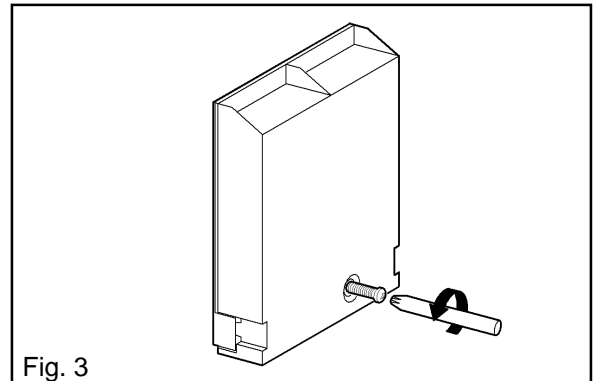

- Prise cover loose using screwdriver in position (1) then lever off with screwdriver in position (2) at either side. See Fig. 4.

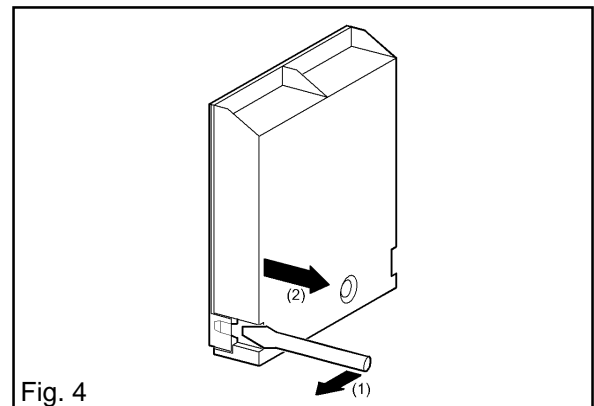

- Lift cover and remove screw from cable clamp. See Fig. 5.

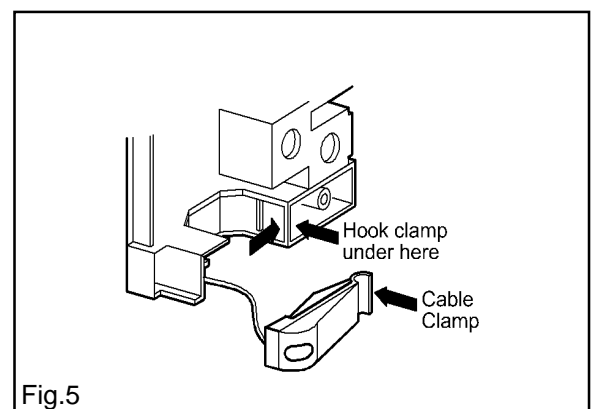

CONNECTING TO MAINS TERMINAL

Warning: This appliance must be earthed.

- Make connection as shown in Fig. 6 by proceeding as follows:-

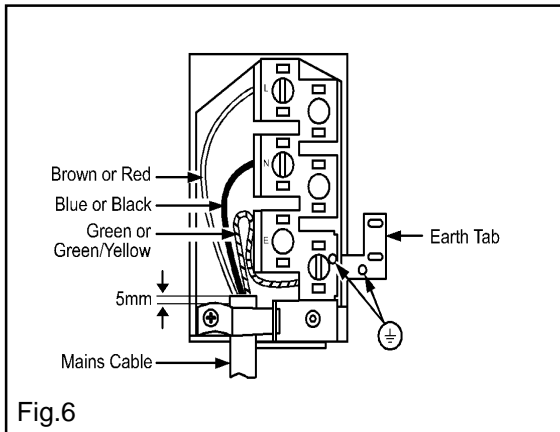

- Preform wires to the appropriate shape to suit fitting into the mains terminal block.
- Strip inner insulation on wires using wirestrippers.
- Twist the bared wires using pliers.
- Cut bared wires 10mm away from the end of the inner insulation. Where uninsulated Earth wires are used ensure they are suitably sheathed to leave 10mm bare wire to fit into the terminal.
- Clamp bare wires into the relevant terminal and check they are held by tugging each one in turn.
- Clamp the mains cable securely ensuring 5mm of the outer insulation is inside the terminal block and that the wires are not taught but not so slack as to cause any fouling. See Fig.6.
- Place fuse/miniature circuit breaker in circuit and switch on at mains.

CONNECTING TO A HOB OR COOKER POINT

WARNING: THIS APPLIANCE MUST BE EARTHED

- Either follow in general terms the instructions for connecting to the terminal block or refer to the hob suppliers installation instructions.

Feed the cable through the cabinet and arrange to route the cable away from the appliance which may become hot.

CHECKING ELECTRICAL CONNECTIONS

- Correct electrical connection can be confirmed when switching on the appliance as the electronic timer will be flashing.

NOTE: HOUSE CIRCUIT

Earth leakage and continuity tests must be carried out before the appliance is connected to the mains supply and re-checked after fitting.

FITTING INTO THE CABINET

IMPORTANT: Ensure that the oven is switched off at the wall before any further work is carried out.

- Using a tape measure establish the internal width of the cabinet. Refer to page 7 if greater than 565 mm.
- Position the appliance in front of the cabinet. See Fig. 7.
- Take out all oven furniture before installation to reduce the weight you need to lift. The oven door should be taped up to keep it closed whilst lifting.
- To place the appliance into the cabinetry follow the procedure below:
- N.B. Two people will be required to carry out the lifting procedure.
 - a) Each person should squat either side of the appliance.
 - b) Tilt the appliance so that your hands can support the underside of the appliance.
 - c) Keeping your back straight, raise the appliance to the cabinet by straightening at the knees.
 - d) Rest the rear underside of the appliance on the cabinet floor while your hands support the front.
 - e) The appliance can be pushed fully into the cabinet. Take care to avoid fouling the mains lead.
 - f) Ensure the appliance is central in the cabinet and level.
 - g) **Do not** remove spacers fitted behind fixing holes.
 - h) When the appliance is fully housed screw the stability screws (supplied with the appliance) into the side of the cabinet taking care not to distort the side trims (See Fig 8). It is advisable to turn each screw alternatively to avoid damaging the trims.
 - i) Switch on the appliance then refer to the operating instructions in the following pages.

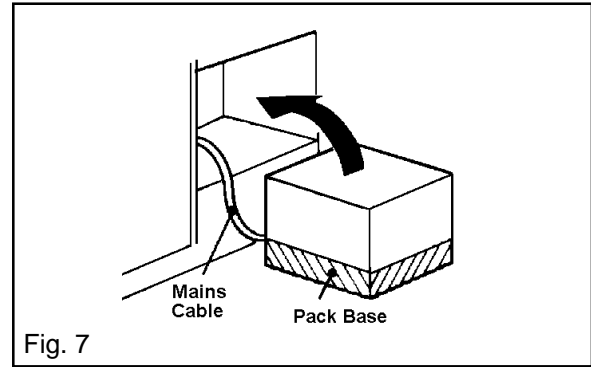

Fig. 7

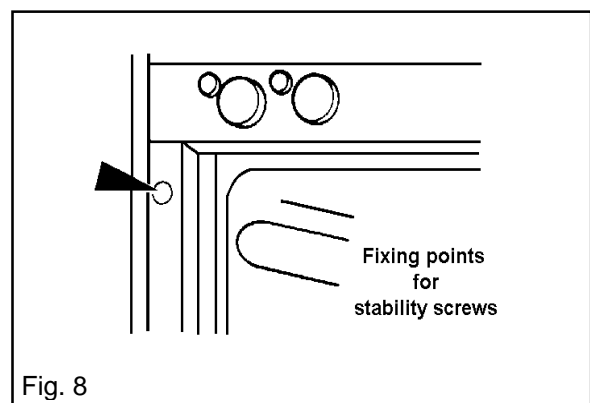
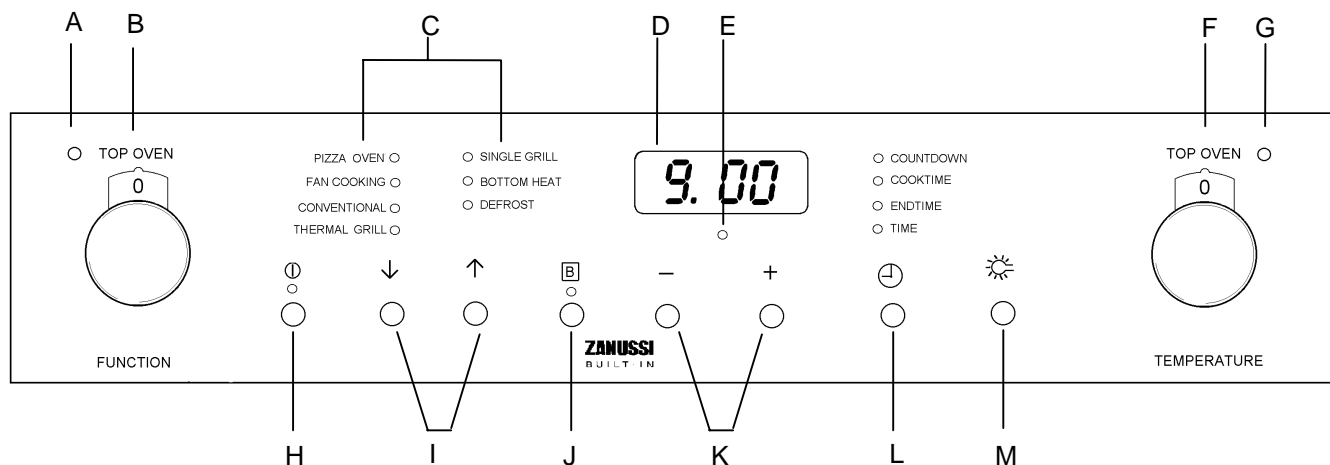

Fig. 8

INTRODUCTION

WARNING: THIS APPLIANCE MUST BE EARTHED

GETTING TO KNOW YOUR APPLIANCE



- | | | | | | |
|---|---|-------------------------------|---|---|--------------------------------------|
| A | - | Top Oven Function Neon | H | - | On/Off Switch and Neon |
| B | - | Top Oven Function Selector | I | - | Main Oven Function Selectors |
| C | - | Main Oven Functions | J | - | Boost Button and Neon |
| D | - | Main Oven Electronic Display | K | - | Main Oven Temperature/Time Selectors |
| E | - | Main Oven Temperature Neon | L | - | Timer Function Selector |
| F | - | Top Oven Temperature Selector | M | - | Main Oven Light |
| G | - | Top Oven Temperature Neon | | | |

INTRODUCTION

WHEN FIRST SWITCHING ON

The oven has a 24 hour clock. When the oven is first switched on at the wall the oven lights may illuminate momentarily and the electronic display will automatically show 0.00, and the 'Time' neon will also flash.

To set the time of day and use the timer refer to instructions on page 15.

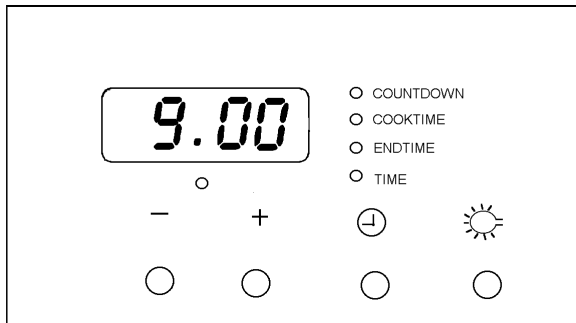

RATING PLATE

This is situated on the lower front frame of the appliance and can be seen upon opening the top cavity door. Alternatively the rating plate may also be found on the back or top of some models (where applicable).

The appliance must be protected by a suitably rated fuse or circuit breaker. The rating of the appliance is given on the rating plate.

Do not remove the rating plate from the appliance as this may invalidate the guarantee.

GENERAL NOTES ON USING THE OVENS

We suggest that you run the oven elements for 10 – 15 minutes at 220°C to burn off any residue from their surfaces.

The procedure should be repeated with the grill for approximately 5 – 10 minutes.

During this period an odour may be emitted, it is therefore advisable to open a window for ventilation.

ABOUT CONDENSATION AND STEAM

When food is heated it produces steam similar to a boiling kettle. The ovens are vented to allow some of the steam to escape. However, always stand back from the appliance when opening the oven door to allow any build up of steam or heat to release.

If the steam comes into contact with a cool surface on the outside of the appliance, e.g. a trim, it will condense and produce water droplets. This is quite normal and is not caused by a fault on the appliance. To prevent discolouration, regularly wipe away condensation and also soilage from surfaces.

COOKWARE

Baking trays, dishes etc., should not be placed directly against the grid covering the fan at the back of the oven.

Do not use baking trays larger than 30cm x 35cm (12" x 14") as they will restrict the circulation of heat and may affect performance. Advice on the effect of different materials and finishes of bakeware is given in 'Hints and Tips' in the appropriate oven section.

THE COOLING FAN FOR THE CONTROLS

The cooling fan comes on immediately when the grill or top oven is switched on and after a short time when the main oven is in use. It may run on after the controls are switched off until the appliance has cooled. During the initial period the cooling fan may turn ON and OFF, this is quite normal.

⚠ Always allow the cooling fan to cool the appliance down before switching off at the wall prior to carrying out any cleaning or maintenance work.

CONTROL PANEL INDICATOR NEONS



These lights indicate whether the grill or ovens are switched ON. In the case of the ovens, the temperature neons also indicate when the set temperature has been reached. The temperature neon will go out when the oven has reached the set temperature. It will turn on and off during cooking to show that the oven temperature is being maintained. If the neons do not operate as the instructions indicate the controls have been incorrectly set. Return all controls to zero and reset following the instructions for the required setting.

ON/OFF PUSH BUTTON



The oven must be switched on before setting any cooking function or programme. When the on/off button is pressed, the neon below symbol  will come on.

To switch off the oven, you can press button  at any time. Any cooking function or programme will stop, the oven light will switch off and the Main Oven electronic display will show the time of day only.

OVEN FUNCTION CONTROL PUSH BUTTONS (MAIN OVEN)

Push buttons  or  to allow you to select the cooking function. Each time you push these buttons a neon will come on in the Oven Function Display, showing what cooking function has been chosen.

INCREASE AND DECREASE PUSH BUTTONS (MAIN OVEN)

Push buttons  and  allows you to increase or decrease temperature or time settings.

GRILL AND OVEN FURNITURE

The following items of grill and oven furniture have been supplied with the appliance. If you require replacements of any of the items listed below please contact your local Service Force Centre, quoting the relevant part number.

1 grill pan
(311409401)

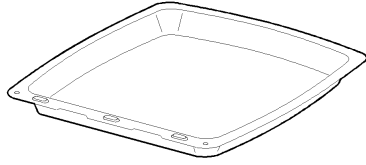

1 grill pan handle
(311468100)

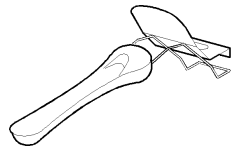

Note

If you require an additional handle for your grill pan, this can be ordered from your local Service Force Centre by quoting part number 311479800\6.

1 grill pan grid
(311419801)

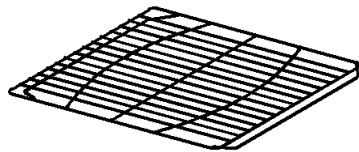

1 meat tin
(311409401)

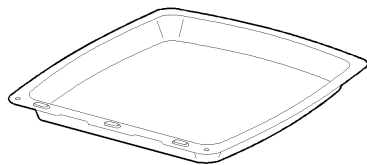

1 cranked shelf
(for grilling
and top oven
cooking only)

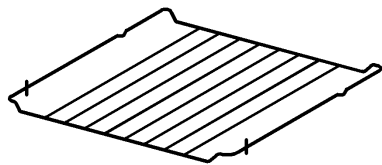

2 straight shelves
(for main oven
cooking)

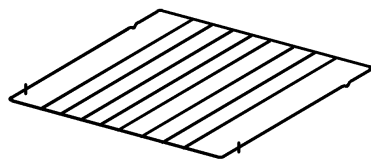

ELECTRONIC OVEN CONTROL

KEY

- A ELECTRONIC DISPLAY
- B TIMER FUNCTION NEONS
- C MAIN OVEN TEMPERATURE SELECTORS
- D TIMER FUNCTION SELECTOR
- E MAIN OVEN LIGHT

NOTE:

The time of day must be set before the main oven will operate manually.

1. HOW TO SET THE TIME OF DAY

The oven has a 24 hour clock.

When the electricity supply is first switched on, the oven lights will illuminate momentarily and the electronic display will flash 0.00, the 'Time' neon will also flash as Fig 1.

If numbers are flashing:

Press buttons — or + until the correct time on the 24 hour clock is reached. When the correct time is displayed, leave the controls for 5 seconds and the 'Time' neon will stop flashing and remain constant to confirm your time setting as Fig 2.

If numbers are static:

If you wish to reset the time, simply press ⌚ 4 times or until the neon scrolls to 'Time'. The 'Time' neon will flash. Press buttons — or + until the desired time is reached. After 5 seconds the neon will remain constant to confirm your time setting.

Note: The increase and decrease control buttons operate slowly at first, and then more rapidly. They should be pressed separately.

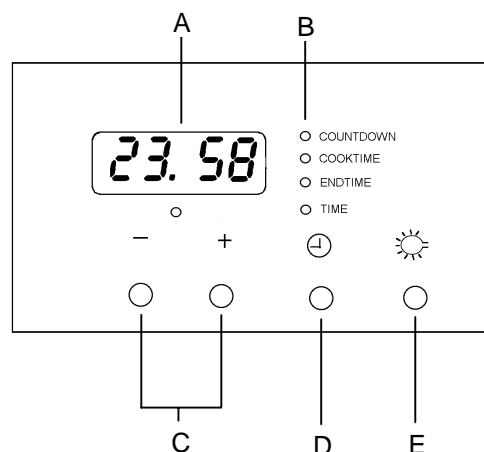

Fig 1.

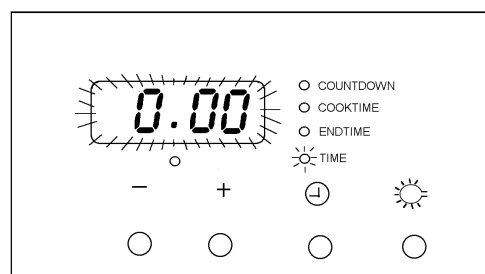
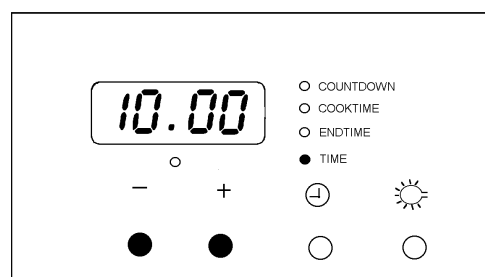





Fig 2.



2. HOW TO SET THE COUNTDOWN

The 'Countdown' gives an audible reminder at the end of any period of cooking up to 1 hr 30 minutes. It is not part of the automatic control.

1. Press button  to select the 'Countdown' function. The relevant neon will flash and the control panel will display 0.00.
2. Press button  or  to select the required time, e.g. 45 minutes as Fig 3. The 'Countdown' neon will wait 3 seconds and then start running. The Countdown neon will remain constant.

NOTE: This must be completed within 5 seconds of first pressing the  button.

3. The display will countdown the programmed time in minutes.
4. When the programmed time has elapsed, an acoustic alarm will be heard, and 0.00 will show on the control panel. The oven will **NOT** switch off if in use.
5. To switch off the acoustic alarm, press any button as Fig 4. The control panel will display the time of day and the 'Countdown' neon will go out.

TO CANCEL THE COUNTDOWN



Press button  and the 'Countdown' neon will flash. Press button  till 0.00 is displayed as Fig 5. After 5 seconds the time of day will be restored.

Fig 3.

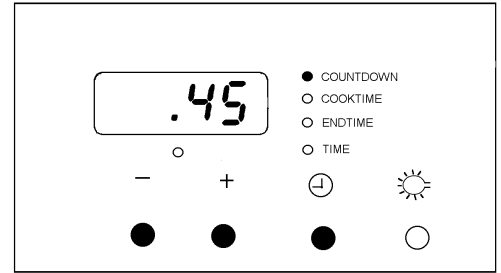

Fig 4.

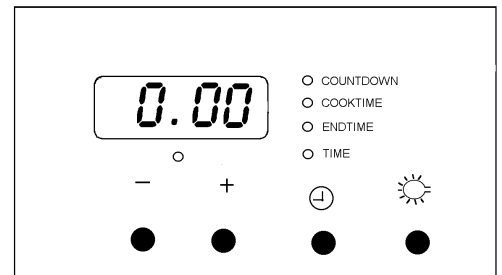
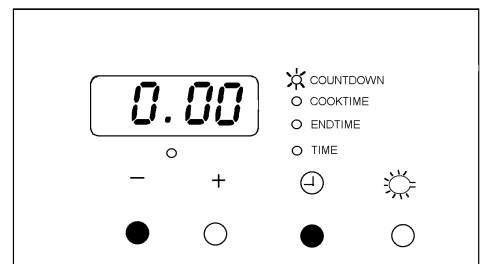

Fig 5.









3. HOW TO SET THE OVEN TIMER CONTROL

The main oven only can be automatically timed.

When using the timer control for the very first time, it is advisable to let it operate while you are at home. The displays can be checked to show that it is operating correctly and you will feel confident to leave a meal to cook automatically in the future.

A) TO SET THE TIMER TO SWITCH ON AND OFF AUTOMATICALLY

1. Ensure the electricity supply is switched ON and that the correct time of day is displayed, e.g. 10.am. as Fig. 6.
2. Press button  repeatedly until the 'Cooktime' function is selected. The neon will flash and the control panel will display 0.00 as Fig 7.
3. Press buttons  or  to select the required time (up to 23 hours 59 minutes). The programmer will wait 5 seconds and the start running. The 'Cooktime' neon will remain constant and the display will revert to the temperature set.
4. Press button  and scroll down until the 'Endtime' function is selected, the neon will flash. The control panel will display the end of cooking time (that is, the actual time plus cooking duration). See Fig 8.
5. If this is not the time you require, press button  or  within 5 seconds to select the required end of cooking time.
6. Place food in the oven, select a cooking function and set the cooking temperature.
7. The oven will switch on and off automatically. The end of cooking will be marked by an acoustic alarm.

To switch off the acoustic alarm, press any button.

The control panel will display the time of day and the 'Endtime' neon will go off, see Fig 9.

Fig 6.

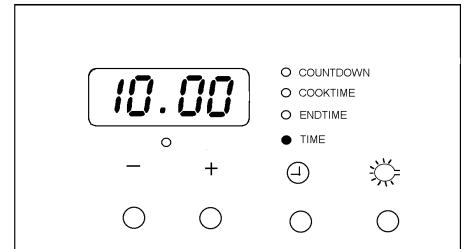

Fig 7.

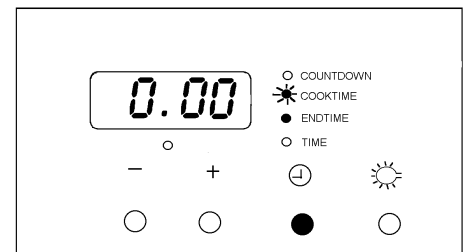

Fig 8.

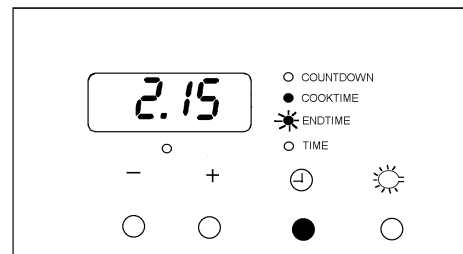
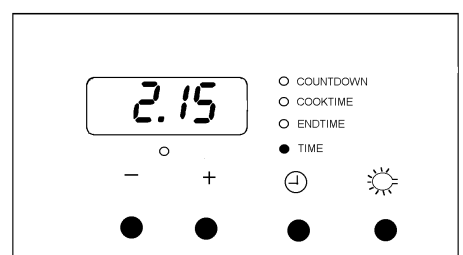





Fig 9.





B) TO SET THE TIMER TO SWITCH OFF ONLY

1. Ensure the electricity supply is switched ON and that the correct time of day is displayed, e.g. 10.00am as Fig. 10.
2. Place food in the oven.
3. Press button  repeatedly until the 'Endtime' function is selected. The neon will flash and the control panel will display 0.00 as Fig 11.
4. Press buttons  or  to select the required time (up to 19 hours 59 mins). The programmer will wait 5 seconds and then start running. The 'Endtime' neon will remain constant and the display will revert to the temperature set.
5. The oven will switch off automatically. The End of cooking will be marked by an acoustic alarm, the neon will flash and the control panel will display 0.00.

To switch off the acoustic alarm, press any button. The control panel will display the time of day and the 'Endtime' neon will go out as Fig 12.

TO CANCEL AN AUTOMATIC PROGRAMME

To cancel an automatic programme simply cancel the 'Cooktime'. Scroll through the timer selector until the 'Cooktime' neon is illuminated. Press button  and while keeping it pressed, press button  too.

If this operation is carried out while a programme is running on, the oven will NOT switch off.

AUTOMATIC COOKING

It is advisable to leave food in the oven for as short a time as possible before automatic cooking. Always ensure commercially prepared food is well within its use by date and that home prepared food is fresh and of good quality.

When cooking is complete, **do not** leave food to stand in the oven, but remove and cool it quickly if the food is not to be consumed immediately.

Always ensure food in the oven has been covered before cooking if it is not possible to remove food immediately after cooking.

Fig 10.

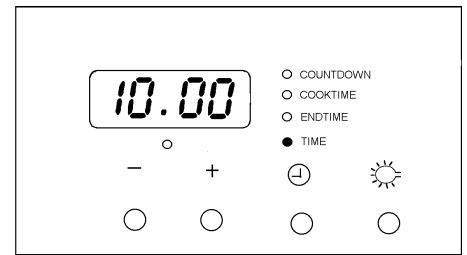

Fig 11.

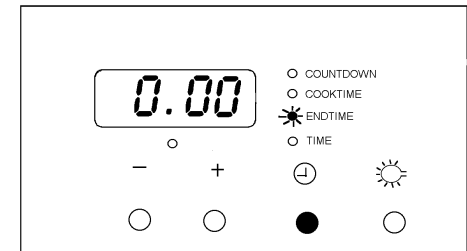
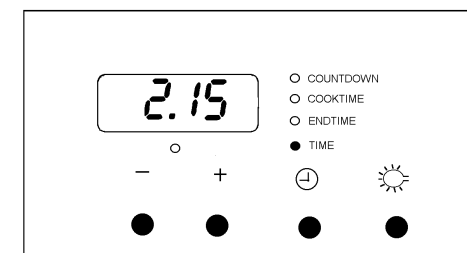
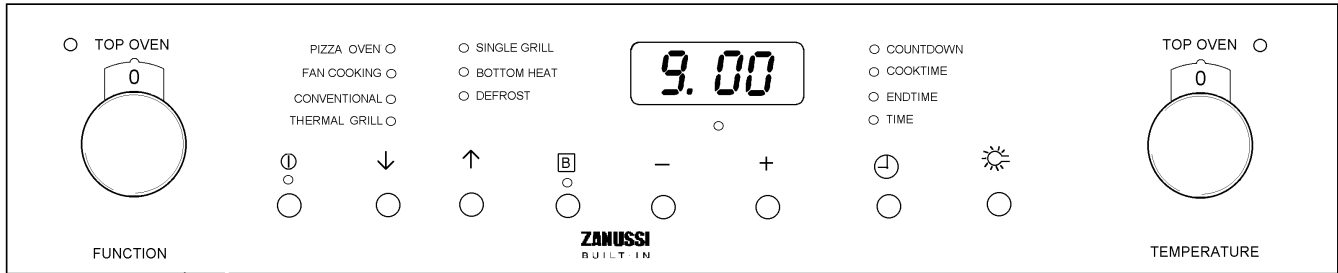

Fig 12.



HOW TO SELECT MAIN OVEN COOKING FUNCTIONS & TEMPERATURE



The main oven is provided with 7 different cooking functions. For each of them, a pre-set temperature will be automatically selected.

1. Press button \uparrow or \downarrow to select the required oven function. Each time button \uparrow or \downarrow is depressed, a neon will flash on next to the currently selected function. Once you have selected the function you require wait 5 seconds and the neon will stop flashing and remain constant confirming your choice.
2. The temperature will set automatically. If the pre-set temperature is not suitable, press button $-$ or $+$ to adjust the temperature in 5 degree steps until the required temperature setting is reached.

You can also get the current main oven internal temperature by pressing buttons $-$ or $+$ together. The temperature will be displayed for 10 seconds and then it will return to the set temperature. If the internal temperature is higher than the selected temperature (e.g. when a cooking function has been completed the oven is hot) the internal temperature will not be displayed.

To switch off a function simply press \uparrow or \downarrow once. The neon will go out and the display will return to the time of day.

TO FIT THE MAIN OVEN SHELVES

The shelves should be fitted with the straight rods uppermost on the frame and the forms towards the back of the oven. If not fitted correctly the anti-tilt and safety stop mechanism will be affected.

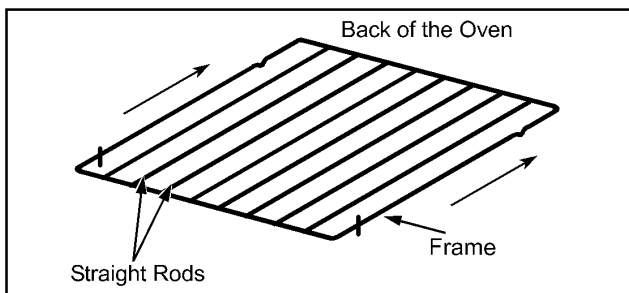

COOKING FUNCTIONS

Pizza Baking - This setting can be used for foods such as pizzas, quiches or pies, where base browning and crispness are required. The top and lower elements operate in conjunction with the fan oven.

Fan Cooking - This setting allows you to roast or roast and bake simultaneously using any shelf, without flavour transference.

Conventional Cooking - The heat comes from both the top and bottom element, ensuring even heating inside the oven.

Thermal Grilling/Fan Assisted grilling.

This function offers an alternative method of cooking food items, normally associated with conventional grilling. The grill element and the oven fan operate together, circulating hot air around the food. **Select a maximum temperature of 220°C.**

Single Grill - The full grill element will be on.

Bottom Heating Element - The heat comes from the bottom of the oven only, to allow you to finish your dishes.

Defrost - Defrosts most foods faster than some conventional methods. It is particularly suitable for delicate frozen foods which are to be served cold.

BOOST FUNCTION & PIZZA OVEN FUNCTION

BOOST FUNCTION

USES OF BOOST FUNCTION

After a cooking function has been selected and the temperature has been adjusted, the cavity will gradually heat up until the selected temperature is reached. This will take from 10 to 15 minutes, depending on selected function and temperature. If it is necessary to reach the required temperature in a shorter time, the Boost Function can be used.

The Boost Function is ideal for quick preheating of the oven before selecting an alternative cooking function.

SELECTING THE BOOST FUNCTION

- 1) Set the required cooking function and temperature as explained in the previous pages.
- 2) Press button **B** once. The neon will illuminate.
- 3) When the required temperature is reached, an acoustic alarm will sound for a short time, and the indicator neon will turn off.

This function cannot be used with single grill and defrost functions.

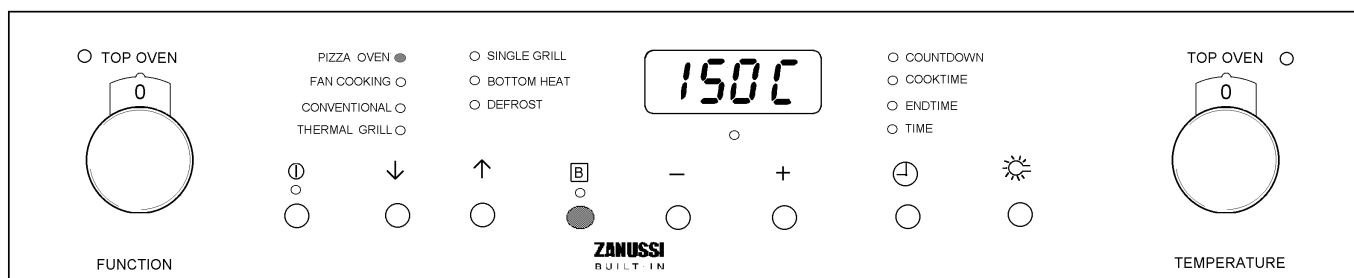

PIZZA OVEN FUNCTION

USES OF PIZZA OVEN FUNCTION

This setting can be used for foods such as pizza where base browning and crispness are required.

The top and lower elements operate in conjunction with the oven fan.

SELECTING THE PIZZA FUNCTION

- Scroll through the main oven function selector using \uparrow or \downarrow until the 'Pizza Oven' neon is illuminated.
- Wait 5 seconds until your choice is confirmed and the neon stops flashing.
- The temperature will automatically set to 150°C. If you wish to alter the set temperature you may wish to do so by pressing $-$ or $+$ until the required temperature setting is reached.

THINGS TO NOTE

1. The main oven indicator neon will glow until the oven has reached the desired temperature and then go out. It will turn ON and OFF periodically during cooking showing that the temperature is being maintained.
2. The cooling fan for the controls may operate after a time. It may run on after the controls are switched off until the appliance has cooled. See page 13 for further details on the operation of the cooling fan.
3. The internal oven light will come on.

HINTS AND TIPS

- Single level cooking using shelf positions 4 or 5 gives best results.
- Ensure that food is placed centrally on the shelf for maximum air circulation.
- Be guided by the cook times and temperature given on any packaging.
- Some pizzas should be cooked directly on the oven shelf. To prevent soiling the oven base, place a baking tray in one of the lower shelf positions.

 **Dishes, tins or trays should not be placed directly on the oven floor as it becomes very hot and damage will occur.**

- The material and finish of the baking trays and dishes used will affect base browning. Enamelware, dark heavy or non-stick utensils increase base browning, while oven glassware, shiny aluminium or polished steel trays reflect the heat away and give less base browning.

THE MAIN OVEN FAN COOKING

USES OF THE FAN OVEN

PREHEATING

The fan oven quickly reaches its temperature so it is not usually necessary to preheat the oven. Without preheating however you may need to add an extra 5 – 10 minutes on the recommended cooking times. For recipes needing high temperatures e.g. bread, pastries, scones, soufflés etc., best results are achieved if the oven is preheated first. For best results when cooking frozen or cooked chilled ready meals preheat the oven first.

COOKING TEMPERATURES

Fan oven cooking generally requires lower temperatures than conventional cooking. Follow the temperatures recommended in the chart on page 24. As a guide reduce temperatures by 20°C - 25°C for your own recipes.

BATCH BAKING

The Fan oven cooks evenly on all shelf levels, especially useful when batch baking.

SELECTING THE FAN OVEN

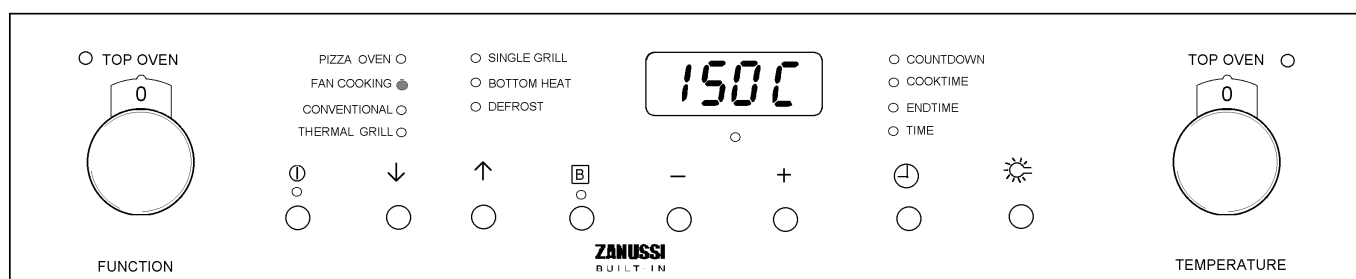

- Scroll through the main oven function selections using \uparrow or \downarrow until the 'Fan Cooking' oven neon is illuminated.
- Wait 5 seconds until your choice is confirmed and the neon stops flashing. The temperature will automatically set to 150°C.
- If you wish to alter the set temperature, you may do so by pressing $-$ or $+$ until the required temperature setting is reached.

THINGS TO NOTE

1. The main oven indicator neon will glow until the oven has reached the desired temperature and then go out. It will turn ON and OFF periodically during cooking showing that the temperature is being maintained.
2. The oven fan will operate continually during cooking.
3. The cooling fan for the controls operates after a period of time. It may run on after the controls are switched off, until the appliance has cooled. See page 13 for further details on the operation of the cooling fan.
4. The internal oven light will come on.

HINTS AND TIPS

- Arrange the shelves in the required positions before switching the oven on. Shelf positions are counted from the bottom upwards.

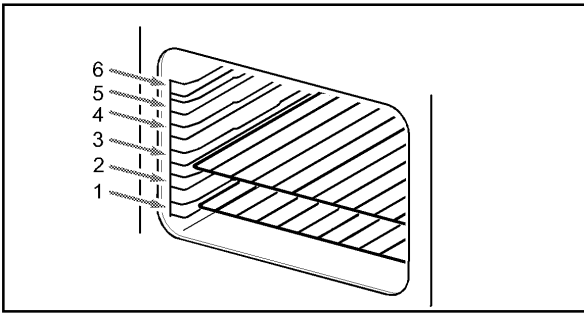

- When cooking more than one dish in the fan oven, place dishes centrally on different shelves rather than cluster several dishes on one shelf, this will allow the heat to circulate freely for the best cooking results.
- When batch baking one type of food, e.g. Victoria sandwich cakes, those of similar size will be cooked in the same time.

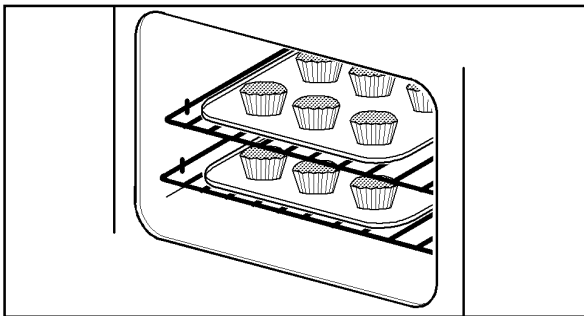

- It is recommended that when baking larger quantities, the shelf positions should be evenly spaced to suit the load being cooked. A slight increase in cooking time may be necessary.

 **DO NOT place cookware and cooking pots with rough bases e.g. cast iron on the oven door as damage to the glass may occur.**

- **DO NOT** place baking trays directly on the oven floor as it interferes with the oven air circulation and can lead to base burning; use the lower shelf position.

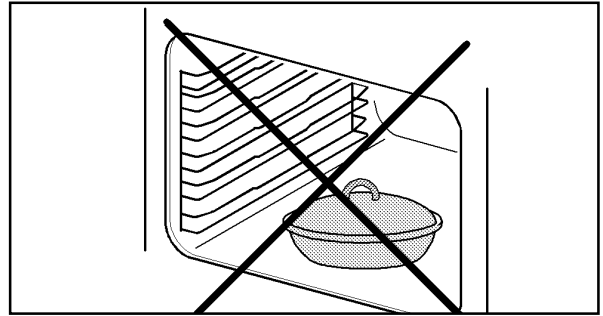

- The use of excessively high temperatures can cause uneven browning. It may be necessary to reduce temperatures slightly. Refer to the recommendations given in the oven cooking chart, on page 24.

THE MAIN OVEN - CONVENTIONAL SETTING

USES OF THE CONVENTIONAL OVEN

This main oven function uses the top and lower elements to give single level cooking. This is particularly suitable for dishes which require extra base browning such as pizzas, quiches and flans. Gratins, lasagnes and hotpots which require extra top browning also cook well in the conventional oven. This form of cooking gives you the opportunity to cook without the fan oven in operation.

SELECTING THE CONVENTIONAL OVEN

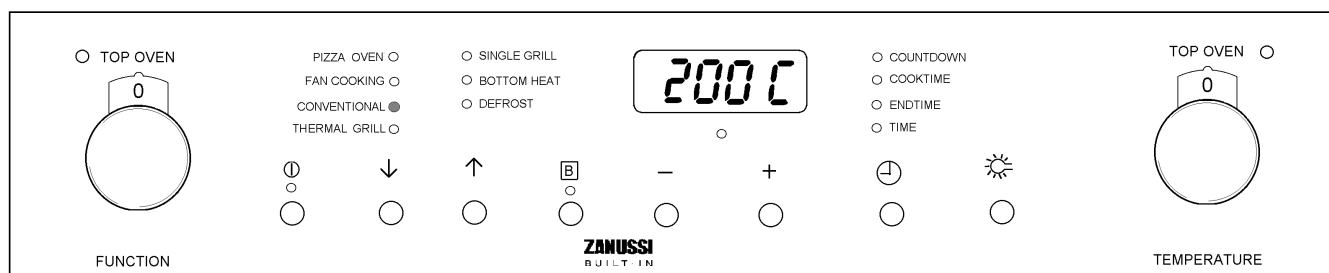

- Scroll through the main oven function selections using \uparrow or \downarrow until the 'Conventional' neon is illuminated.
- Wait 5 seconds until your choice is confirmed and the neon stops flashing.
- The temperature will automatically set to 200°C.
- If you wish to alter the set temperature, you may do so by pressing $-$ or $+$ until the required setting is reached.

THINGS TO NOTE

1. The main oven indicator neon will glow until the oven has reached the desired temperature and then go OUT. It will turn ON and OFF periodically during cooking showing that the oven temperature is being maintained.
2. The cooling fan for the controls may operate after a time. It may run on after the controls are switched off until the appliance has cooled. See page 13 for further details on the operation of the cooling fan.
3. The internal oven light will come on.

OVEN COOKING CHART

The oven temperatures are intended as a guide only. It may be necessary to increase or decrease the temperatures by 10°C to suit individual preferences and requirements.

Food	FAN OVEN		CONVENTIONAL OVEN	
	Shelf Position	Cooking Temp °C	Shelf Position	Cooking Temp °C
Biscuits		180-190	3	180-190
Bread		210-220	3	200-220
Casseroles		130-140	3	150-180
Cakes: Small & Queen	positions	160-170	4	170-180
Sponges	are not	160-170	3	160-180
Madeira		140-150	3	160-170
Rich Fruit	critical	130-140	3	140-160
Christmas	but ensure	130-140	2	130-140
Meringues		80-100	3	90-110
Fish	that oven	170-190	3	170-190
Fruit Pies and Crumbles	shelves are	190-200	4	190-200
Milk Puddings		130-140	4	130-140
Pastry: Choux	evenly	190-200	3	160-170
Shortcrust	spaced	190-200	4	190-200
Flaky		210-220	4	210-220
Puff	when more	Follow manufacturer's instructions		
Plate Tarts	than one is	180-190	3	190-200
Quiches/Flans		170-180	3	190-200
Scones	used	210-220	4	220-230
Roasting: Meat and Poultry		160-180	3	180-200

ROASTING CHART

ROASTING CHART		
INTERNAL TEMPERATURES – Rare : 50-60°C; Medium : 60-70°C; Well done : 70-80°C		
MEAT	TOP/FAN OVEN	COOKING TIME
Beef	160-180°C	20-35 minutes per ½kg (1lb) and 20-35 minutes over
Beef, boned	160-180°C	25-35 minutes per ½kg (1lb) and 25-35 minutes over
Mutton and Lamb	160-180°C	25-35 minutes per ½kg (1lb) and 25-35 minutes over
Pork and Veal	160-180°C	30-40 minutes per ½kg (1lb) and 30-40 minutes over
Ham	160-180°C	30-40 minutes per ½kg (1lb) and 30-40 minutes over
Chicken	160-180°C	15-20 minutes per ½kg (1lb) and 20 minutes over
Turkey and Goose	160-180°C	15-20 minutes per ½kg (1lb) up to 3½kg (7lb) then 10 minutes per ½kg (1lb) over 3½kg (7lb)
Duck	160-180°C	25-35 minutes per ½kg (1lb) and 25-30 minutes over
Pheasant	160-180°C	35-40 minutes per ½kg (1lb) and 35-40 minutes over
Rabbit	160-180°C	20 minutes per ½kg (1lb) and 20 minutes over
Potatoes with meat	160-180°C	according to size
Potatoes without meat	180-190°C	according to size

The roasting temperatures and times given in the chart should be adequate for most joints, but slight adjustments may be required to allow for personal requirements and the shape and texture of the meat. However, lower temperatures and longer cooking times are recommended for less tender cuts or larger joints.

Wrap joints in foil if preferred, for extra browning uncover for the last 20 – 30 min. cooking time.

THERMAL FAN ASSISTED GRILLING

USES OF THERMAL FAN ASSISTED GRILLING

Thermal fan assisted grilling offers an alternative method of cooking food items normally associated with conventional grilling.

The grill element and the oven fan operate together, circulating hot air around the food. The need to check and turn food is reduced. Thermal fan assisted grilling helps to minimise cooking smells in the kitchen and allows you to grill with the oven door closed.

With the exception of toast and rare steaks you can thermal grill all the foods you would normally cook under a conventional grill.

The lower part of the oven can be used to cook accompaniments at the same time, e.g. tomatoes and mushrooms with a mixed grill or breakfast.

Dishes prepared in advance such as shepherd's pie, lasagne and au gratin's can be heated through and browned on the top using the thermal grilling function.

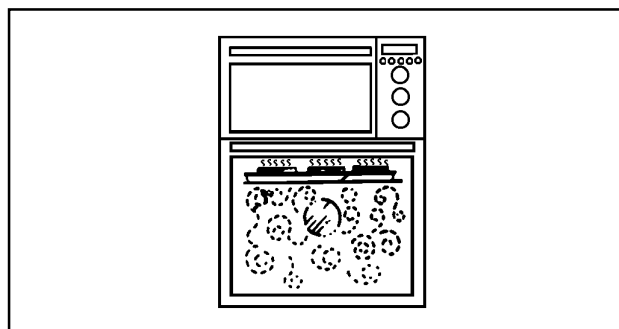

SELECTING THERMAL GRILLING

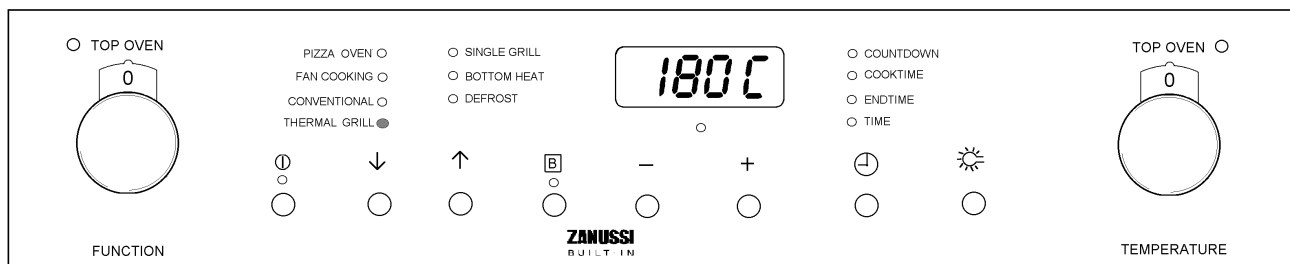

- Scroll through the main oven function selections using \uparrow or \downarrow until the 'Thermal Grill' neon is illuminated.
- Wait 5 seconds until your choice is confirmed and the neon stops flashing. The temperature will automatically set to 180°C.
- If you wish to alter the set temperature, you may do so by pressing $-$ or $+$ until the required setting is reached.
- A temperature of between 140°C and 220°C is suitable for thermal grilling.

THINGS TO NOTE

1. The main oven indicator neon will glow until the oven has reached the desired temperature and then go OUT. It will turn ON and OFF periodically during cooking showing that the oven temperature is being maintained.
2. The oven fan and internal oven light will come on.
3. The cooling fan for the controls may operate after a time. It may run on after the controls are switched off until the appliance has cooled. See page 13 for further details on the operation of the cooling fan.
4. Always keep the oven door closed and the grill handle removed when cooking with thermal fan assisted grilling.

HINTS AND TIPS

- Prepare foods in the same way as for conventional grilling. Brush lean meats and fish lightly with a little oil or butter to keep them moist during cooking.

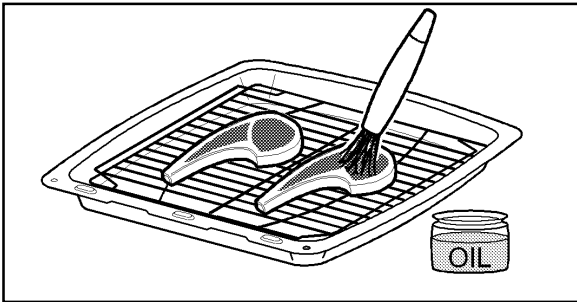

- Most food should be placed on the grill pan grid in the 'high' position in the grill pan to allow maximum circulation of air around the food.
- Accompaniments such as tomatoes and mushrooms may be placed below the grid when grilling meats, or in a separate dish on a lower shelf.

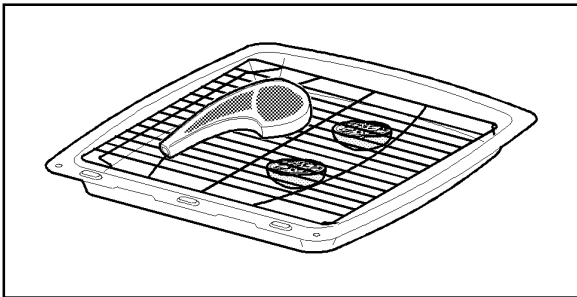

- Foods will cook more quickly the closer they are to the grill element and the higher the temperatures selected. Be prepared to adjust temperatures and shelf positions during cooking if necessary.
- Turn food over during cooking as necessary.
- Ensure that ready prepared or cooked chilled dishes e.g. shepherds pie, moussaka, lasagne, etc., are piping hot throughout before serving.
- A temperature range of 140°C - 220°C and shelf positions 3 and 4 are suitable for most foods. Be prepared to make suitable adjustments during cooking to suit individual requirements. If thermal grilling on more than one level, it may be necessary to interchange the food on the shelves during cooking.

COOKING TIMES

Cooking is more gentle, therefore food generally takes a little longer to cook when thermal grilling compared with conventional grilling. One of the advantages is that larger loads can be cooked at the same time.

A general guide to cooking times is given on this page but these times may vary slightly depending on the thickness and quantity of food being cooked.

THERMAL FAN ASSISTED GRILLING CHART

FOOD	SHELF	TEMP (°C)	TIME (mins In total)
Bacon Rashers	4	200	8-12
Beefburgers	4	190	10-15
Chicken Joints	4	160	35-45
Chops - Lamb/Pork	4	170	20-25
		170	25-35
Fish - Whole			
Trout/Mackerel	3	170	10-20
Fillets - Plaice/Cod	3	170	10-15
Kebabs	4	170	20-30
Kidneys - Lamb/Pig	4	180	10-15
Liver - Lamb/Pig	4	180	30-30
Sausages	4	190	10-15
Steaks - Medium	4	220	8-10
			each side
Steaks - Well Done	4	220	10-12
			each side
Heating through and Browning, e.g.	3	170	20-30
Au -gratin, Lasagne, Shepherd's Pie.			depends on size

NOTE: Shelf positions are counted from the bottom of the oven.

Times quoted above are given as a guide and should be adjusted to suit personal taste.

THE MAIN OVEN - GRILL

CAUTION - ACCESSIBLE PARTS MAY BECOME HOT WHEN THE GRILL IS IN USE. CHILDREN SHOULD BE KEPT AWAY.

SELECTING THE MAIN OVEN SINGLE GRILL

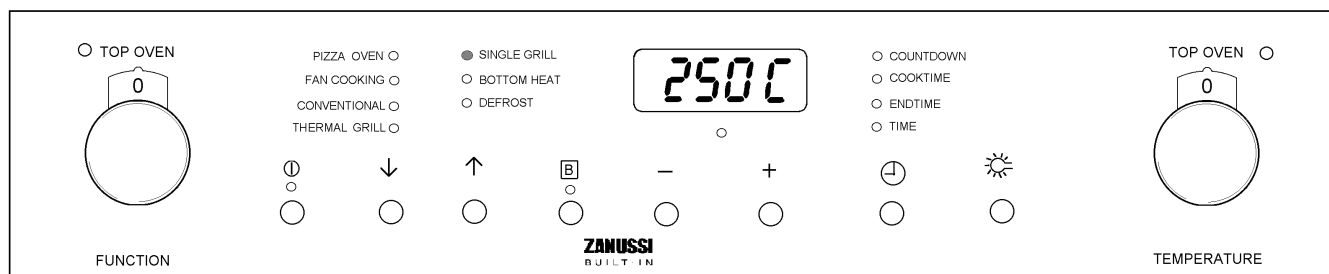

- Scroll through the main oven function selections using \uparrow or \downarrow until the 'Single Grill' neon is illuminated.
- Wait 5 seconds until your choice is confirmed and the neon stops flashing.
- The temperature will automatically set 250°C.
- If you wish to alter the set temperature, you may do so by pressing $-$ or $+$ until the required setting is reached.

THINGS TO NOTE

1. The cooling fan for the controls will operate in conjunction with the grill. It may run on after the controls are switched off, until the appliance has cooled. See page 13 for further details on the operation of the cooling fan.
2. The inner element may appear to glow slightly brighter than the outer element. This is quite normal.
3. Some smoke from fat splashes may be evident as the grill cleans itself.

USING THE TELESCOPIC RUNNERS (WHERE FITTED)

1. Ensure the telescopic runners are pushed back into the oven cavity before fitting the shelf.
2. Holding the front edge of the shelf with both hands, place the rear shelf forms over the telescopic runners.
3. Slide the shelf into position, lifting slightly at the front so that the shelf locates into the retaining hooks.

To remove, raise the front edge and withdraw the shelf.

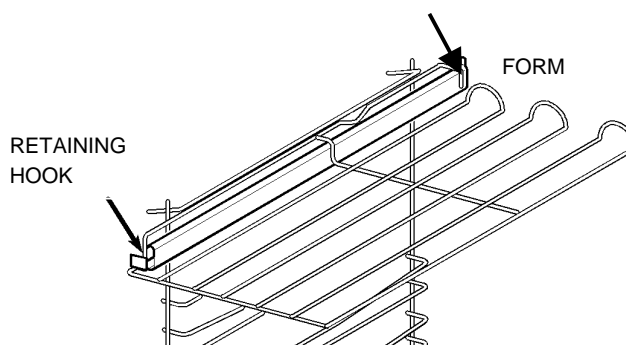

Ensure the shelf is positively located before using.

Note

Should you wish to purchase a telescopic runner kit, this can be ordered from your local Service Centre by quoting part number (BAZD02).

THE GRILL PAN AND HANDLE

The grill pan is supplied with a removable handle.

To attach the handle, place the wirework under the cut out in the pan so that the metal plate hooks over the top of the grill pan.

Slide the handle to the left and over the central bump on the grill pan.

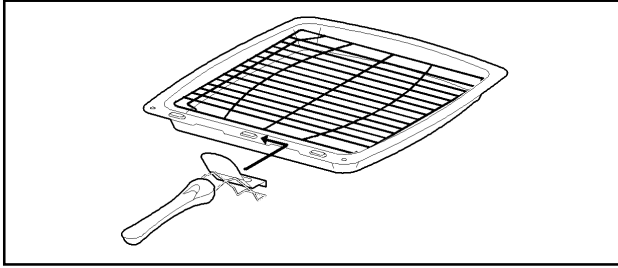

Ensure the handle is correctly located. It is not necessary to remove the grill pan handle during grilling.

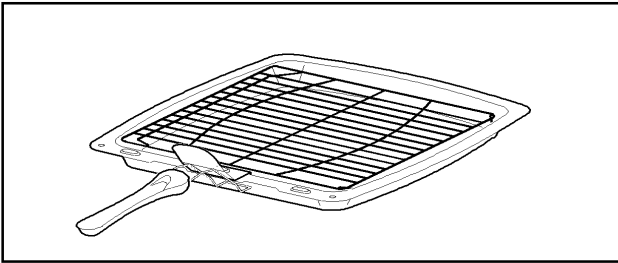

To remove the handle, slide the handle to the right and lift the handle away from the cut out on the grill pan.

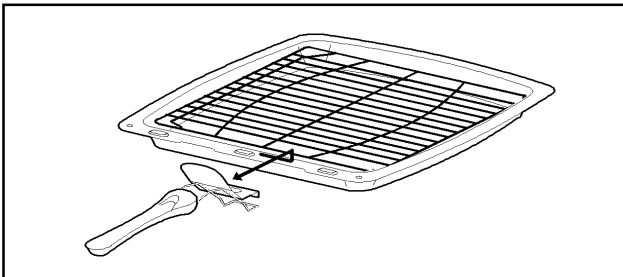

Place the grill pan on the shelf so that the pan is positioned centrally beneath the grill.

To check the progress of the food being grilled, the grill pan should be withdrawn to attend food during cooking.

If your model is fitted with telescopic runners in position 3, the grill pan can be withdrawn on the shelf.

⚠ DO NOT attempt to close the door if the telescopic shelf supports are not completely inside the grill. This could damage the door glass and handle.

HINTS AND TIPS

- Most foods should be placed on the grid in the grill pan to allow maximum circulation of air to lift the food out of the fats and juices. Food such as fish, liver and kidneys may be placed directly on the grill pan base if preferred.
- Food should be thoroughly dried before grilling to minimise splashing. Brush lean meats and fish lightly with a little oil or melted butter to keep them moist during cooking.

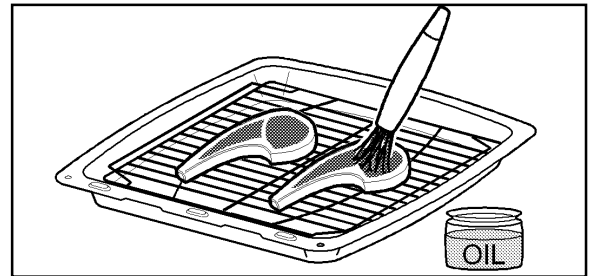

- Adjust the grid and grill pan runner position to allow for different thicknesses of food. Position the food close to the element for faster cooking and further away for more gentle cooking.
- Accompaniments such as tomatoes and mushrooms may be placed underneath the grid when grilling meats.

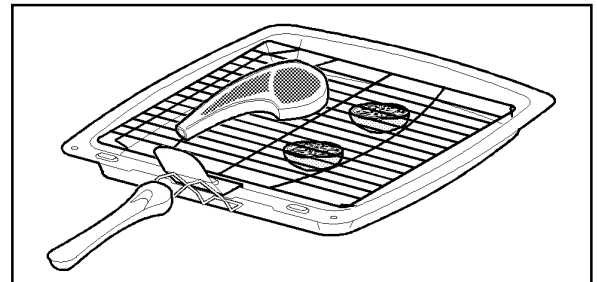

- When toasting bread, we suggest that the top runner position is used with the grid in its 'high' position.
- Preheat the grill on a full setting for a few minutes before sealing steaks or toasting. Adjust the heat setting and the shelf as necessary during cooking.
- The food should be turned over during cooking as required.

NOTE

If you require an additional handle for your grill pan, this can be ordered from your local Service Force Centre by quoting part number 311479800\6.

GRILLING CHART

FOOD	GRILL TIME (mins in total)
Toast	4-6
Bacon Rashers	10
Beefburgers	10-15
Chicken Joints	30-40
Chops - Lamb	15-20
Pork	20-30
Fish – Whole Trout/Mackerel	15-25
Fillets – Plaice/Cod	15
Kebabs	20-30
Kidneys – Lamb/Pig	8-12
Sausages	20-30
Steaks - Rare	6-12
Medium	12-16
Well Done	14-20
Toasted Sandwiches	3-4

The times quoted above are given as a guide and should be adjusted to suit personal taste.

BOTTOM HEAT

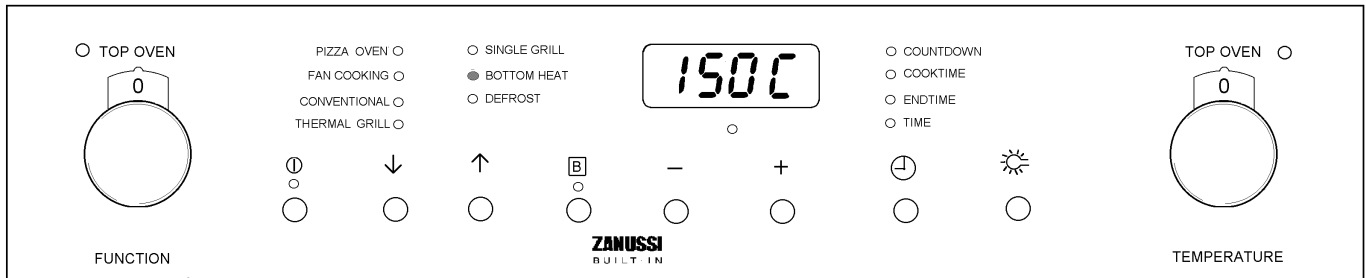





USES OF THE BOTTOM HEAT FUNCTION

This function can be used to finish off dishes that may require extra base heat or where base browning and crispness are required by pizzas or pies.

Some pizzas should be cooked directly on the oven shelf. To prevent soiling the oven base, place a baking tray in one of the lower positions.

 **Do not place dishes, tins or baking trays directly on the oven base as damage will occur.**

SELECTING THE BOTTOM HEAT FUNCTION

- Towards the end of the 'Cook' time, scroll through the main oven function selectors using  or  until the 'Bottom Heat' neon is illuminated.
- Wait 5 seconds until your choice is confirmed and the neon stops flashing.
- The temperature will automatically set to 150°C.
- If you wish to alter the set temperature you may do so by pressing  or  until the required temperature setting is reached.

NOTE

This function should not be used for the entire cooking time. It is intended as a support function only.

THE EFFECTS OF DISHES ON COOKING RESULTS

Dishes and tins vary in their thickness, conductivity, colour, etc, which affects the way they transmit heat to the food inside them. The material and finish of the baking trays and dishes used will affect base browning.

- Aluminium, earthenware, oven glassware and bright shiny utensils reduce cooking and underneath browning.
- Enamelled cast iron, anodised aluminium, aluminium with non-stick interior and coloured exterior and dark, heavy utensils increase cooking and underneath browning.
- Always place dishes centrally on the shelf to ensure even browning.

DEFROST FEATURE

USES OF DEFROST FEATURE

This main oven function defrosts most foods faster than more conventional methods. It is particularly suitable for delicate frozen foods which are to be served cold, e.g. cream filled gateaux, cakes covered with icings or frostings, cheesecakes, biscuits, scones, etc.

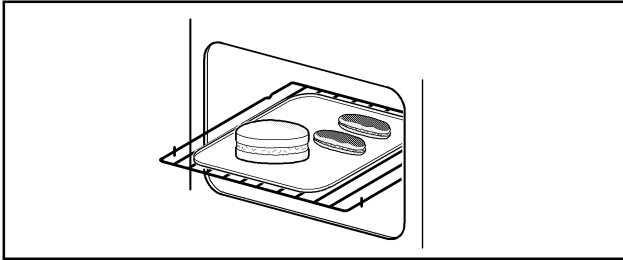

It is preferable to thaw fish, meat and poultry slowly in the fridge. However, this process can be accelerated by using the defrost function.

SELECTING DEFROST

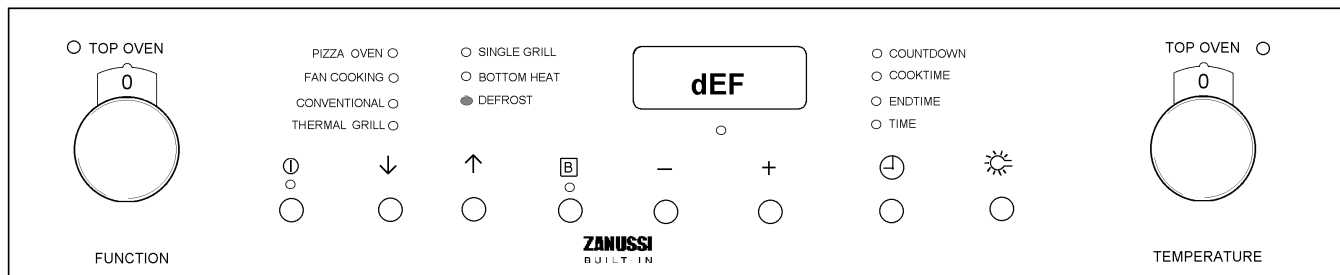

- Scroll through the main oven function selections using \uparrow or \downarrow until the 'Defrost' neon is illuminated.
- Wait 5 seconds until your choice is confirmed and the neon stops flashing.
- The temperature display will show 'dEF'.
- The oven fan and internal oven light will come on
- To switch the defrost function off, just press button \uparrow or \downarrow once again. The main oven electronic display will show the time of day.

THINGS TO NOTE

1. The oven indicator neon may glow and turn on and off when defrosting
2. The oven fan and oven light will come on
3. The cooling fan does not operate

Care must always be taken when handling foods in the home. Always follow the basic rules of food hygiene to prevent bacterial growth and cross contamination when defrosting, preparing, cooking, cooling and freezing foods.

Small or thin fish fillets, frozen peeled prawns, cubed or minced meat, liver, thin chops, steaks etc., can be thawed in 1 – 2 hours.

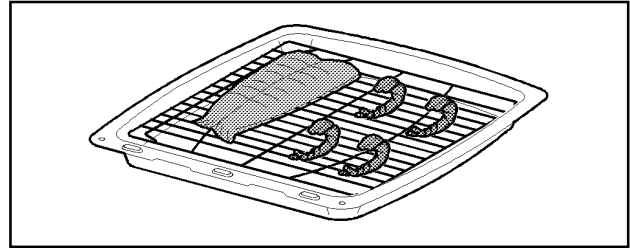

A 1kg/2¼lb oven ready chicken will be thawed in approximately 5 hours. Remove the giblets as soon as possible during the thawing process.

Joints of meat up to 2kg/4½lb in weight can be thawed using the defrost function.

ALL JOINTS OF MEAT AND POULTRY MUST BE THAWED THOROUGHLY BEFORE COOKING

ALWAYS COOK THOROUGHLY IMMEDIATELY AFTER THAWING.

HINTS AND TIPS

- Place the frozen food in a single layer where possible and turn it over half way through the defrosting process.

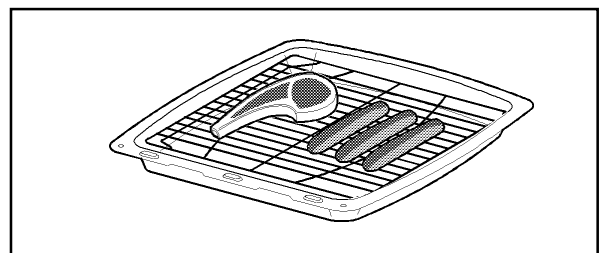



- The actual speed of defrosting is influenced by room temperature. On warm days defrosting will be faster than on cooler days.
- **DO NOT** leave food at room temperature once it is defrosted. Cook raw food immediately or store cooked food in the fridge, once it has cooled.

MAIN OVEN LIGHT

SELECTING THE MAIN OVEN LIGHT

The oven light illuminates the main oven when a main oven cooking function and temperature has been selected.

- If you do not want the cavity to be illuminated whilst you are cooking you can press the  button which will switch the main oven light off.
- To turn the main oven light on again, or to switch the light on whilst the oven is not in operation, press the  button once.

For more information of replacing the main oven light bulb turn to page 43.

SAFETY AND ENERGY SAVING FUNCTIONS

SAFETY CUT-OFF FUNCTION







If no changes are made to the oven settings, the oven will switch off automatically, according to the following table.

If temperature setting is:	The oven will switch off:
250°C or more	after 1 ½ hours
From 120°C up to 250°C	after 5 hours
Less than 120°C	after 12 hours

CHILD SAFETY FUNCTION

To avoid children switching on the oven when the appliance is switched off, it is possible to lock the oven controls on both the main and second ovens individually.

MAIN OVEN

- 1) Press buttons  and  at the same time and keep them pressed for about 3 seconds. An audible signal will be heard and SAFE will now be shown in the main oven electronic display. The display will revert to the time of day after 10 seconds.
- 2) The main oven is now locked. Neither oven functions nor temperatures can be selected.
- 3) To unlock the main oven if no buttons have been depressed. Press buttons  and  at the same time and keep them pressed for about 3 seconds. An audible signal will be heard. The oven can now be operated normally.
- 4) To unlock the main oven if SAFE is illuminated in the display. Press  to return the display to the time of the day. Now press  and  at the same time and keep them pressed for about 3 seconds. The oven can now be operated normally.

THE TOP OVEN



USES OF THE TOP OVEN

The second oven is the smaller of the two ovens. It is heated by elements in the top and bottom of the oven. It is designed for cooking smaller quantities of food. It gives especially good results if used to cook fruit cakes, sweets and savoury flans or quiche.

The second oven is also ideal for use as warming compartment to warm dishes and keep food hot. Use a temperature setting of 90°C – 100°C on the oven temperature control.

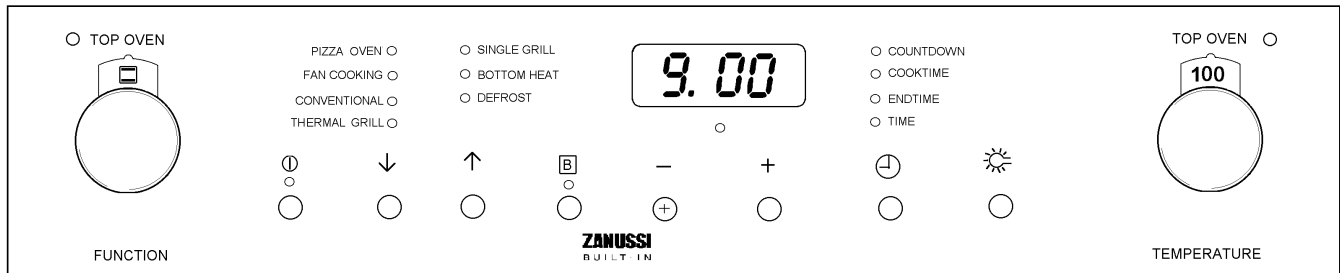
SELECTING THE TOP OVEN



- Conventional Setting 
- Base Element Only 
- Top Element Only 

Conventional Setting

- Turn the top oven function selector to 
- Turn the top oven temperature control to the required setting.

Additional Functions and

- These functions can be used to finish off dishes that may require extra base heat, e.g. pizza or pies, or top browning e.g. au gratin dishes.
- Towards the end of the cook time turn the oven selector to the required function.

NOTE

These functions should not be used for the entire cooking time. They are intended as a support function only.

Base Element Only

- Turn the top oven function selector to 
- This function is particularly useful for foods such as pizza where base browning and crispness are required.
- Some pizzas should be cooked directly on the oven shelf. To prevent soiling the oven base, place a baking tray in one of the lower positions.



Do not place dishes, tins or baking trays directly on the oven base as damage will occur.

Top Element Only

- Turn the top oven selector to 
- This function is particularly useful for items such as cauliflower cheese or au gratin dishes which may require top browning before serving.

THINGS TO NOTE

1. The top oven indicator neon will glow until the oven has reached the desired temperature and then go out. It will turn ON and OFF periodically during cooking showing that the temperature is being maintained.
2. The cooling fan for the controls may operate, after a period of time.
3. Dishes, tins or trays should not be placed directly on the top oven base as it becomes very hot and damage will occur.

TO FIT THE TOP OVEN SHELF

The cranked shelf should be fitted with the straight rods uppermost on the frame and the forms towards the back of the oven. If not fitted correctly the anti-tilt and safety stop mechanism will be affected.

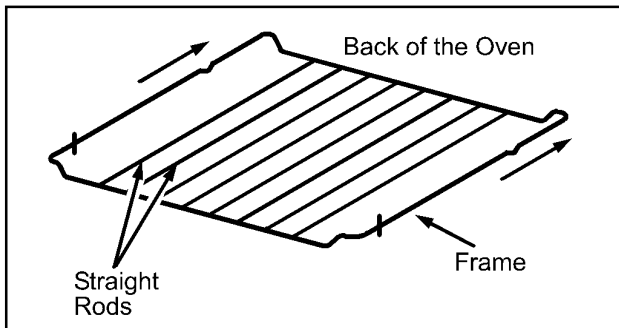

USING THE TELESCOPIC RUNNERS

(where fitted)

1. Ensure the telescopic runners are pushed back into the oven cavity before fitting the shelf.
2. Holding the front edge of the shelf with both hands, place the rear shelf forms over the telescopic runners.
3. Slide the shelf into position, lifting slightly at the front so that the shelf locates into the retaining hooks.

To remove, raise the front edge and withdraw the shelf.

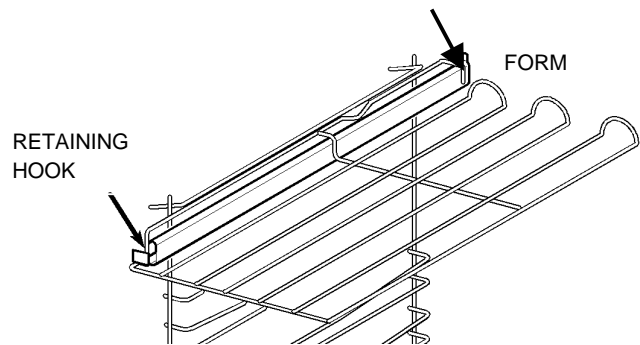

Ensure the shelf is positively located before using.

Note

Should you wish to purchase a telescopic runner kit, this can be ordered from your local Service Centre by quoting part number (BAZD02).

HINTS AND TIPS

- All cooking should be carried out on shelf positions one and two using a cranked shelf.

When more space is required, for example when roasting or casseroles, a straight shelf from the main oven may be placed on the top oven base.

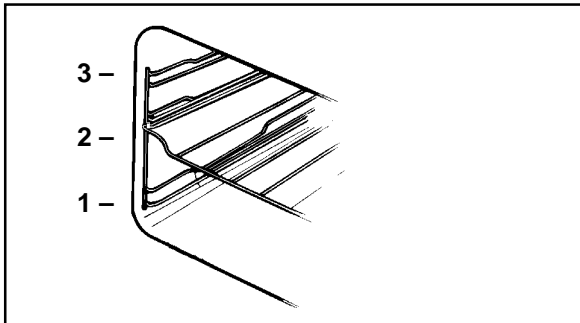

- Arrange the shelves in the required positions before switching the oven ON. Shelves are numbered from the bottom upwards.
- There should always be at least 2.5cm (1") between the top of the food and the element. This gives best cooking results and allows room for rise in yeast mixtures, Yorkshire puddings etc. When cooking cakes, pastry, scones, bread etc., place the tins or baking trays centrally below the element.

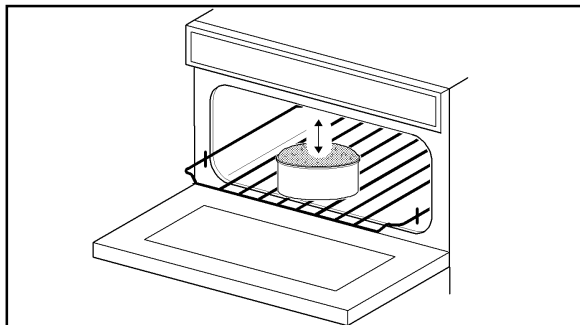

- Ensure that food is placed centrally on the shelf and there is sufficient room around the baking tray/dish to allow for maximum circulation.

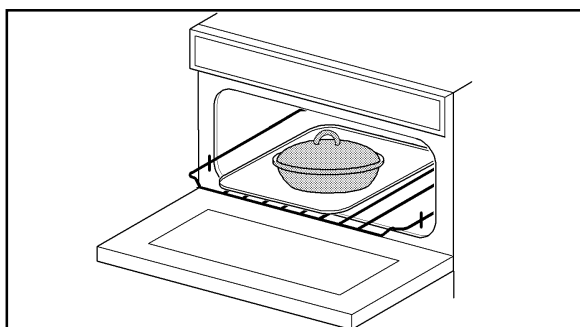

- Stand dishes on a suitably sized baking trays to prevent spillage onto the oven base and to help reduce cleaning.
- **DO NOT** place baking trays directly on the oven floor as it interferes with the oven air circulation and can lead to base burning; use the lower shelf position.
- The material and finish of the baking tray and dishes will affect the degree of base browning of the food. Enamelware, dark, heavy or non-stick utensils increase base browning. Shiny aluminium or polished steel trays reflect the heat away and give less base browning.
- **DO NOT** use the grill pan or meat tin as a baking tray as this will increase base browning of the food.
- Because of the smaller cooking space, lower temperatures and shorter cooking times are sometimes required. Be guided by the recommendations on page 37.

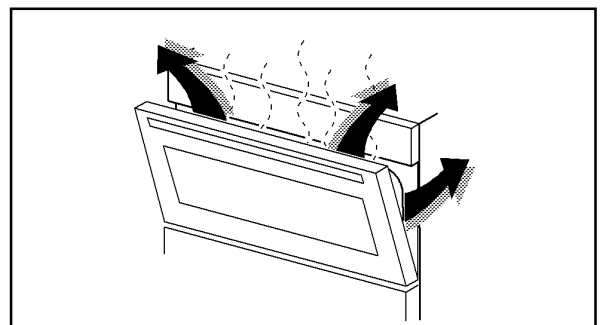

- For economy leave the door open for the shortest possible time, particularly when placing food into a pre-heated oven.

TOP OVEN COOKING CHART

The oven temperatures are intended as a guide only. It may be necessary to increase or decrease the temperatures by 10°C to suit individual preferences and requirements.

FOOD	TOP OVEN		
	SHELF POSITION	COOKING TEMP°C	APPROX COOK TIME (m)
Biscuits	2 crk.	170 - 190	10 - 20
Bread	1 crk.*	200 - 220	25 - 30
Bread rolls/buns	1 crk.	200 - 220	15 - 20
Cakes:			
Small & Queen	2 crk.	180 - 190	18 - 25
Sponges	2 crk.	160 - 170	18 - 20
Victoria Sandwich	2 crk.	160 - 170	18 - 25
Madeira	1 crk.	140 - 150	1¼ - 1½h
Rich Fruit	1 crk.	130 - 140	2¼ - 2½h
Christmas	1 crk.	130 - 140	3 - 4½h
			depends on size
Gingerbread	1 crk.	140 - 150	1¼ - 1½h
Meringues	1 crk.	90 - 100	2½ - 3h
Flapjack	1 crk.	170 - 180	25 - 30
Shortbread	1 crk.	140 - 150	45 - 65
Casseroles:			
Beef/Lamb	1 crk.*	140 - 160	2½ - 3h
Chicken	1 crk.*	180 - 190	1¼ - 1½
Convenience Foods	Follow manufacturer's instructions		
Fish	1 crk.	170 - 190	20 - 30
Fish Pie (Potato Topped)	1 crk.*	190 - 200	20 - 25
Fruit Pies, Crumbles	1 crk.	190 - 200	40 - 50
Milk Puddings	1 crk.	140 - 150	1½ - 2h
Pasta Lasagne etc.	1 crk.	170 - 180	40 - 45
Pastry:			
Choux	1 crk.	180 - 190	30 - 35
Eclairs, Profiteroles	1 crk.	170 - 180	20 - 30
Flaky/Puff Pies	1 crk.*	210 - 220	25 - 40
Shortcrust			
Mince Pies	1 crk.	190 - 200	15 - 20
Meat Pies	1 crk.*	190 - 210	25 - 35
Quiche, Tarts, Flans	1 crk.	180 - 200	25 - 45
Roasting Meat, Poultry	1 crk.*	160 - 180	see roasting chart
Scones	2 crk.	220 - 230	8 - 10
Shepherd's Pie	1 crk.*	190 - 200	30 - 40
Soufflés	1 crk.	170 - 180	20 - 30
Vegetables:			
Baked Jacket Potatoes	1 crk.	180 - 190	1 - 1½
Roast Potatoes	1 crk.	180 - 190	1 - 1½
Yorkshire Puddings:			
Large	1 crk.	200 - 210	25 - 40
Individual	1 crk.	200 - 210	15 - 25

crk. = cranked shelf

*or on a straight shelf on the oven base.

Note: Shelf positions are counted from the bottom of the oven.

Do not use the cranked shelf from the grill in the main oven.

THE TOP OVEN GRILL

USES OF THE TOP OVEN GRILL

CAUTION – ACCESSIBLE PARTS MAY BECOME HOT WHEN THE GRILL IS IN USE. CHILDREN SHOULD BE KEPT AWAY

SELECTING THE TOP OVEN GRILL

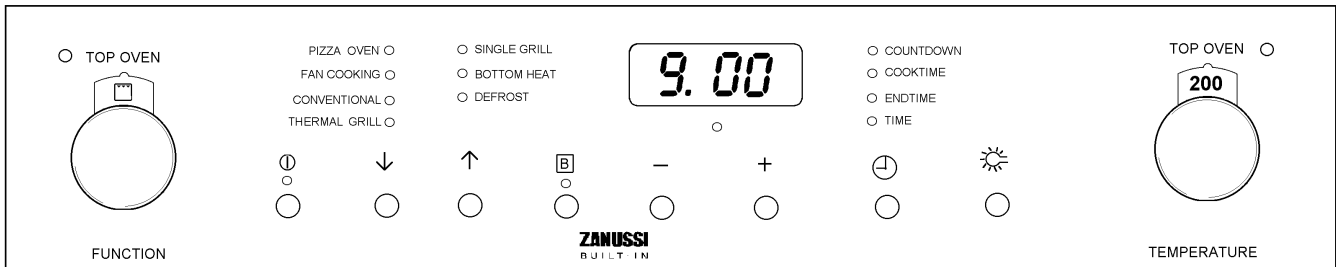

- Select the grill function. 
- Turn the top oven/grill temperature control knob to the right as far as it will go. This is the hottest setting.
- To use the grill at lower settings turn the top oven/grill control knob to 110°C or 90°C.

THINGS TO NOTE

THE GRILL DOOR MUST BE LEFT OPEN DURING GRILLING

The cooling fan for the controls will operate in conjunction with the grill.

The inner grill element may appear to glow slightly brighter than the outer element. This is quite normal.

The grill operates independently of the oven.

THE GRILL PAN AND HANDLE

The grill pan is supplied with a removable handle.

To attach the handle, place the wirework under the cut out in the pan so that the metal plate hooks over the top of the grill pan.

Slide the handle to the left and over the central bump on the grill pan.

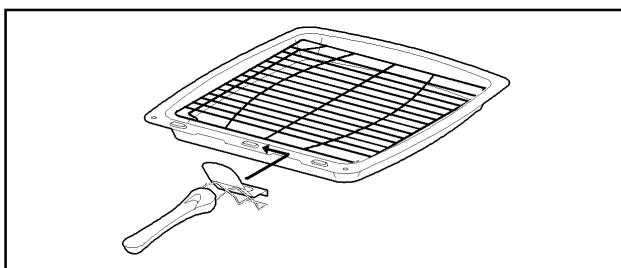

Ensure the handle is correctly located. It is not necessary to remove the grill pan handle during grilling.

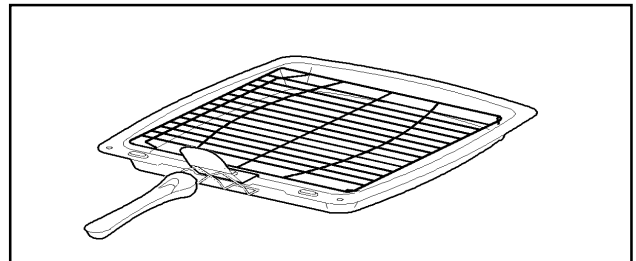

To remove the handle, slide the handle to the right and lift the handle away from the cut out on the grill pan.

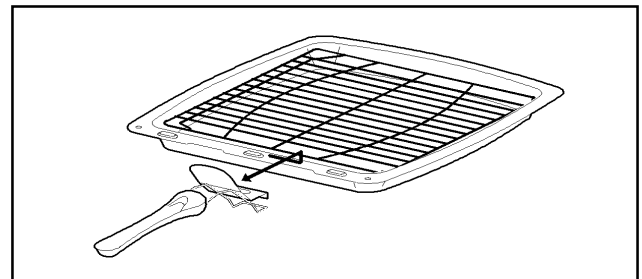

Place the grill pan on the shelf so that the pan is positioned centrally beneath the grill.

To check the progress of the food being grilled, the grill pan should be withdrawn to attend food during cooking.

If your model is fitted with telescopic runners in position 3, the grill pan can be withdrawn on the shelf.

⚠ DO NOT place cookware and cooking pots with rough bases e.g. cast iron on the oven door as damage to the glass may occur.

HINTS AND TIPS

- Most foods should be placed on the grid in the grill pan to allow maximum circulation of air to lift the food out of the fats and juices. Food such as fish, liver and kidneys may be placed directly on the grill pan base if preferred.
- Food should be thoroughly dried before grilling to minimise splashing. Brush lean meats and fish lightly with a little oil or melted butter to keep them moist during cooking.

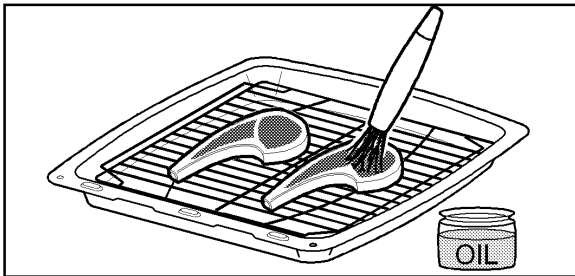

- Adjust the grid and grill pan runner position to allow for different thicknesses of food. Position the food close to the element for faster cooking and further away for more gentle cooking.
- Accompaniments such as tomatoes and mushrooms may be placed underneath the grid when grilling meats.
- When toasting bread, we suggest that the top runner position is used with the grid in its 'high' position.
- Preheat the grill on a full setting for a few minutes before sealing steaks or toasting. Adjust the heat setting and the shelf as necessary during cooking.
- The food should be turned over during cooking as required.

NOTE

If you require an additional handle for your grill pan, this can be ordered from your local Service Force Centre by quoting part number 311479800\6.

TOP OVEN GRILLING CHART

FOOD	RUNNER POSITION	GRILL TIME (mins in total)
Toast	2 crk.	4-6
Bacon Rashers	2 crk.	10
Beefburgers	2 crk.	10-15
Chicken Joints	2 crk.	30-40
Chops - Lamb	2 crk.	15-20
Pork	2 crk.	20-30
Fish – Whole	2 crk.	15-25
Trout/Mackerel	2 crk.	
Filletts – Plaice/Cod	2 crk.	15
Kebabs	2 crk.	20-30
Kidneys – Lamb/Pig	2 crk.	8-12
Sausages	2 crk.	20-30
Steaks - Rare	2 crk.	6-12
Medium	2 crk.	12-16
Well Done	2 crk.	14-20
Toasted Sandwiches	2 crk.	3-4

The times quoted above are given as a guide and should be adjusted to suit personal taste.

CARE AND CLEANING

BEFORE CLEANING ALWAYS ALLOW THE COOLING FAN TO COOL THE APPLIANCE DOWN BEFORE SWITCHING OFF AT THE ELECTRICITY SUPPLY.

CLEANING MATERIALS

Before using any cleaning materials on your appliance, check that they are suitable and that their use is recommended by the manufacturer.

Cleaners that contain bleach should NOT be used as they may dull the surface finishes. Abrasives must also be avoided to prevent damaging the stainless steel or painted finishes.

CLEANING THE OUTSIDE OF THE APPLIANCE

DO NOT use abrasive cleaning materials, e.g. Hob Brite, Brillo pads or scourers on painted or printed finishes as damage may occur.

Regularly wipe over the control panel, oven doors and appliance sides using a soft cloth and hot soapy water. To prevent streaking on stainless steel models finish with a soft cloth. **Any spillage on the stainless steel finish must be wiped off immediately.**

Stainless Steel cream cleaners are abrasive and should be avoided as they may dull the surface finish.

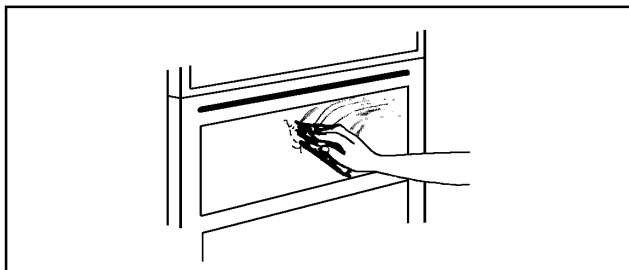

DO NOT ATTEMPT TO REMOVE ANY OF THE CONTROL KNOBS FROM THE PANEL AS THIS MAY CAUSE DAMAGE AND IS A SAFETY HAZARD.

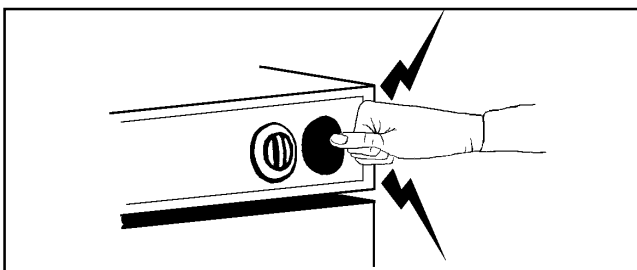

 **Under no circumstances should the door assembly be detached from the product for cleaning. Please refer to the cleaning instructions.**

CLEANING THE GRILL / TOP OVEN COMPARTMENT

The grill / top oven compartment base, sides and back panel can be cleaned using oven cleaners or aerosol oven cleaners with care. Ensure that the manufacturers instructions are followed and that all parts are well rinsed afterwards.

Aerosol cleaners must not come into contact with the grill element as this may cause damage.

CLEANING THE TOP OVEN ROOF

The grill element is hinged to make cleaning the oven roof easier.

 **Switch off the appliance from the electricity supply before cleaning and ensure the oven is cold.**

1. Remove the wirework side runners. See page 42.
2. Undo the two screws which hold the grill element in place.
3. Gently pull the element downwards to allow access to the oven roof. **Do not** force the element downwards.
4. Clean the top of the oven with Cif cream cleaner and a sponge scourer. If heavily soiled, aerosol oven cleaners may be used following the instructions given above for cleaning the grill / top oven compartment.
5. Gently push the grill element back into place.
6. Fit the screws to hold the element in place and tighten firmly.
7. Replace the wirework side runners.

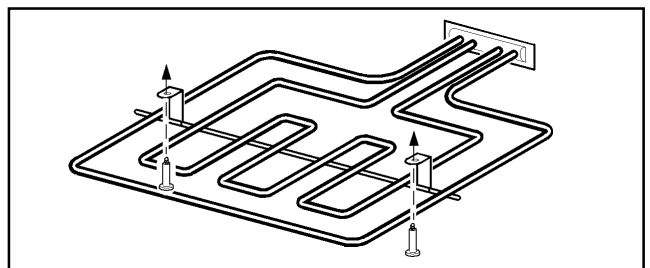

 **Ensure the screws are firmly in place after cleaning.**

CLEANING INSIDE THE MAIN OVEN

The sides and back of the main oven are coated with a Stayclean surface.

The Stayclean surfaces inside the oven should not be cleaned manually. See 'Care of Stayclean Surfaces'.

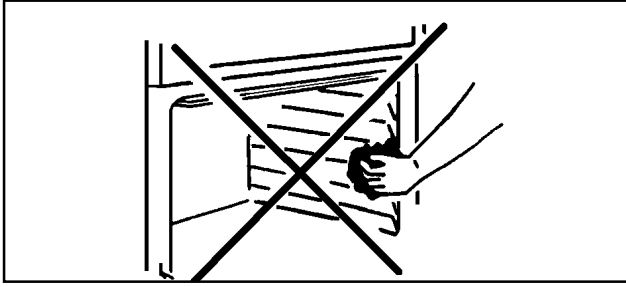

The vitreous enamel in the grill/top compartment and the main oven base can be cleaned using normal oven cleaners or aerosol oven cleaners with care. Ensure that the manufacturers instructions are followed and that all parts are well rinsed afterwards.

Aerosol cleaners must not be used on Stayclean surfaces and must not come into contact with the elements or the door seal as this may cause damage.

CARE OF STAYCLEAN SURFACES

Stayclean surfaces destroy splashes of food and fats when the oven temperature is raised to around 220°C.

It is a good idea to run the oven for an hour or two per week to ensure continued good performance from the Stayclean finish.

HINTS AND TIPS

- Manual cleaning of the Stayclean surface IS NOT recommended. Damage will occur if abrasives or aerosol sprays of any kind are used.
- Slight discolouration and polishing of the Stayclean surfaces may occur in time. This **DOES NOT** affect the Stayclean properties in any way.
- A good time to allow the oven to run on is after the weekly roast. After removing the roast, turn the oven up to 220°C and allow to run for an hour or so. It is important NOT to allow a build-up of soilage as this can prevent the Stayclean surfaces from working.
- Follow the recommendations below to keep oven soilage to minimum.

- Cook at the recommended temperatures. Higher temperatures during roasting will increase soilage. Try cooking at lower temperatures for an increased length of time, you will save energy and often the joint is more tender.
- Use minimal, if any, extra oil or fat when roasting meat, potatoes only require brushing with fat before cooking. Extra fat in the oven during roasting will increase splashing and soilage.
- It is NOT necessary to add water to a meat tin when roasting. The water and the fat juices from the joint create excessive splattering during cooking – even at normal temperatures, as well as causing condensation.
- Covering joints during cooking will also prevent splashing onto the interior surfaces. Removing the covering for the last 20-30 minutes will allow extra browning if required. Some large joints and turkeys especially benefit by this method of cooking, allowing the joint to cook through before the outside is over-browned.

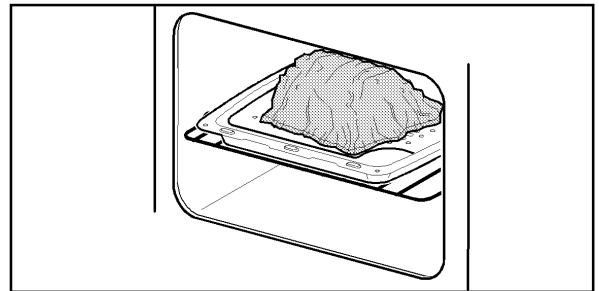

CLEANING THE SHELVES, WIREWORK RUNNERS AND GRILL/OVEN FURNITURE

All removable parts, except the grill pan handle, can be washed in the dishwasher.

The grill pan, grill pan grid, meat tin, oven shelves and wirework runners may be cleaned using a soap impregnated steel wool pad. Soaking first in hot soapy water will make cleaning easier.

TO REMOVE THE WIREWORK RUNNERS

The wirework runners in the grill and oven cavities can be removed for cleaning.

1. Remove all shelves and furniture from the grill and oven compartments.
2. Hold the wirework at the bottom, unclip from the cavity side and gently pull towards the centre of the grill or oven compartment.
3. Unhook the runner at the top and remove from the cavity.
4. To replace, hook the wirework runner back into the grill/oven sides.

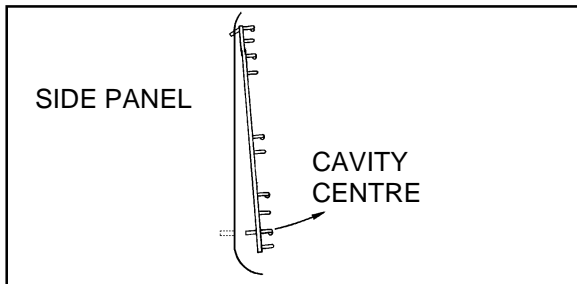

If fitted with telescopic runners, ensure they are pushed back into place in the oven cavity. The telescopic runners should be dried carefully after washing in hot water to which washing up liquid has been added. If heavily soiled mild abrasives may be used.

 **Ensure that the wirework runners are firmly in place before refitting the oven shelves.**

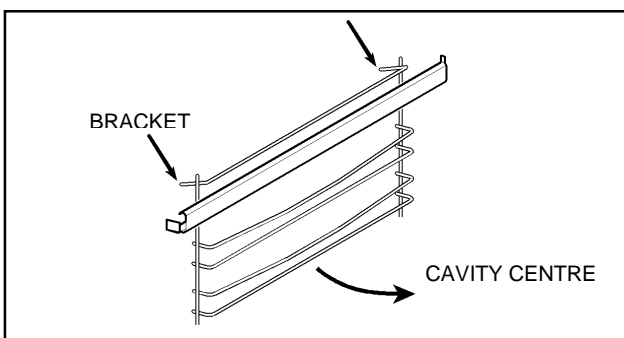

CLEANING BETWEEN THE OUTER AND INNER DOOR GLASS

 To prevent damaging or weakening the door glass panels avoid the use of the following:

- Household detergents and bleaches
- Impregnated pads unsuitable for non-stick saucepans
- Brillo/Ajax pads or steel wool pads
- Chemical oven pads or aerosols
- Rust removers
- Bath/Sink stain removers

 **Under no circumstances should the door assembly be detached from the product for cleaning. Please refer to the cleaning instructions.**

The outer door glass is removable for cleaning.

TO REMOVE THE OUTER GLASS

1. Open the oven door slightly to gain access to the two cross head screws on the top of the oven door.
2. Loosen the two screws using a Pozidrive screwdriver.

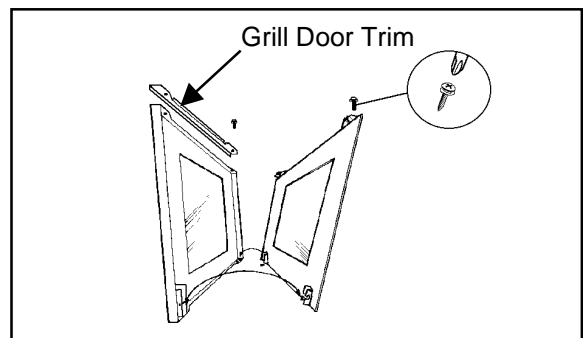

3. Hold the door glass securely in place with one hand before removing the screws completely with the other hand.
4. Using both hands, gently tilt the top of the door glass towards you, lift slightly to disengage the locators from the two bottom brackets. The door will remain in a parked position at an angle of approximately 30°.
5. Clean the outer and inner glass using hot soapy water or Hob Brite may be used with care. **DO NOT** use Hob Brite on the Stainless Steel or painted finishes. **DO NOT** try to clean the foil which is inside the door. The foil is there to help keep the door cool, if it is damaged it will not work. Ensure that all parts are well rinsed and thoroughly dried before attempting to replace the outer door.

 **If the door glass panel becomes chipped or has deep scratches the glass will be weakened and must be replaced to prevent the possibility of the panel shattering. Please contact your local Service Centre who will be pleased to advise further.**

TO REPLACE THE OUTER GLASS

1. Open the oven door with care and place in the park position at an angle of approximately 30°.

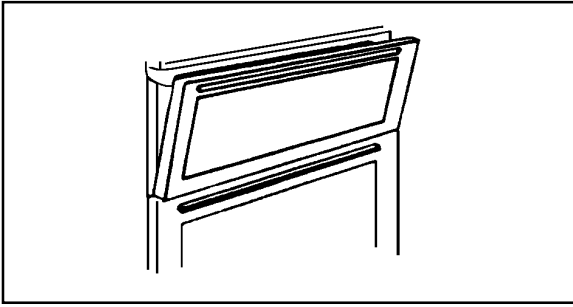

2. Holding the oven glass with both hands, gently place the locators into the holes of the brackets at the bottom of the oven door.
3. Push the top of the oven glass towards the oven door ensuring the screw location holes line up.
4. Ensure the trim is correctly positioned on the top oven / grill door.
5. Hold the glass in place at the top of the door. Insert the cross head screws into the location holes. Give the screws one turn to ensure the glass is secure.
6. Tighten the screws positively with the Pozidrive screwdriver before closing the oven door.

DO NOT attempt to use the oven without the glass being in place.

REPLACING AN OVEN LIGHT BULB

The type of bulb required is a 300°C 25 watt small Edison Screw. Part number 572 491 5431-00/1 (Available through Service Force Centres).

CAUTION: DISCONNECT THE APPLIANCE FROM THE ELECTRICITY SUPPLY BEFORE REPLACING THE BULB.

Open the door and remove the shelves to enable easy access to the oven light assembly. Insert a flat blade screwdriver between the oven side and glass which covers the bulb.

Support the glass with your hand and prise out sufficiently to release the glass cover. Unscrew the bulb in an anticlockwise direction until it is possible to remove the bulb with ease.

Fit the new bulb by turning in a clockwise direction until it is secure. Ensuring the indent to the flange is pointing to the rear of the oven, replace the glass by pushing it firmly into the hole to cover the bulb assembly.

Replace the shelves. Restore the electricity supply and adjust the time of day and clock as necessary.

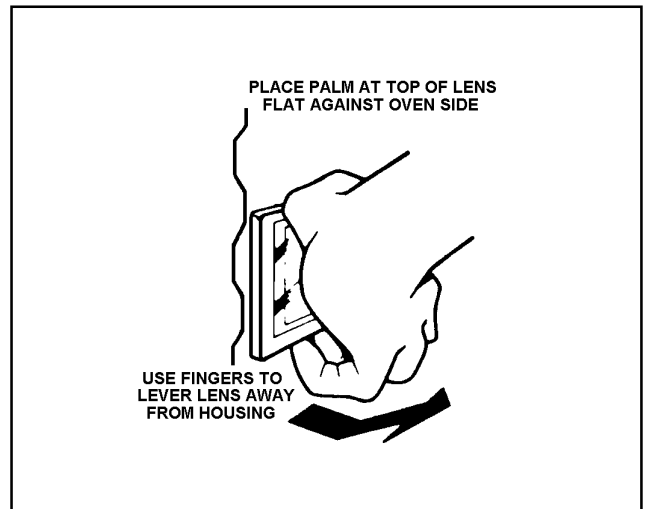

SOMETHING NOT WORKING?

Before calling an Engineer please carry out the following checks, you may be able to solve the problem without the expense of an Engineer.

If our Service Engineer finds that the problem is listed below you will be charged for the call whether or not the appliance is under guarantee.

The grill, ovens and timer do not work.

- * Check that the appliance has been wired in and is switched on at the wall.
- * Check that the main appliance fuse is working.

If you have checked the above:

- * Switch OFF appliance at the wall and allow the appliance to cool for a couple of hours. Switch ON again. The appliance should now be working normally.

The grill works but the main oven does not:

- * Check that the grill control is in the OFF position.
- * Switch OFF at the wall to allow the oven to cool. Check that the oven is now working normally.

The top oven and grill work but the main oven does not.

- * Switch OFF at the wall to allow the oven to cool. Check that the oven is now working normally.

The clock and minute minder do not work.

- * Check that the operating instructions for the timer are being closely followed.

The grill does not work or cuts out after being used for a long period of time.

- * Leave the oven to cool for a couple of hours. Check that the grill is now operating normally. Ensure that the door is left open during grilling.
- * If the cooling fan fails the grill will not work correctly. Contact your nearest Service Force Centre.

The indicator neons are not working correctly.

- * Check you have selected only the function you require.

The oven is not cooking evenly.

- * Check that the appliance is correctly installed and is level.
- * Check that the recommended temperatures and shelf positions are being used.

The oven light fails to illuminate.

- * The oven light bulb may need replacing see page 43.
- * If the main oven is set for automatic cooking the light will illuminate when the cooktime begins

The oven fan is noisy.

- * Check that the oven is level.
- * Check that the shelves and bakeware are not vibrating in contact with the oven back panel.

The oven temperature is too high or too low.

- * Check that the recommended temperatures and shelf positions are being used. See pages 24 and 37. Be prepared to adjust the temperature up or down by 10°C to achieve the results you want.

SERVICE AND SPARE PARTS

In the event of your appliance requiring service, or if you wish to purchase spare parts, please contact your local Service Force Centre by telephoning:-

0870 5 929929

Your telephone call will be automatically routed to the Service Force Centre covering your post code area.

For the address of your local Service Force Centre and further information about Service Force, please visit the website at www.serviceforce.co.uk

Before calling out an engineer, please ensure you have read the details under the heading "Something Not Working".

When you contact the Service Force Centre you will need to give the following details:

1. Your name, address and post code.
2. Your telephone number.
3. Clear and concise details of the fault.
4. The model and serial number of the appliance (found on the rating plate).
5. The purchase date.

Please note that a valid purchase receipt or guarantee documentation is required for in-guarantee service calls.

CUSTOMER CARE DEPARTMENT

For general enquires concerning your Zanussi appliance, or for further information on Zanussi products, please contact our Customer Care Department by letter or telephone at the address below or visit our website at www.zanussi.co.uk

Customer Care Department
Zanussi
55 – 77 High Street
Slough
Berkshire
SL1 1DZ
0870 5 727727 (*)

*calls to this number may be recorded for training purposes.

GUARANTEE CONDITIONS

Standard guarantee conditions

We, Zanussi, undertake that if within 24 months of the date of the purchase this Zanussi appliance or any part thereof is proved to be defective by reason only of faulty workmanship or materials, we will, at our option repair or replace the same FREE OF CHARGE for labour, materials or carriage on condition that:

- The appliance has been correctly installed and used only on the electricity supply stated on the rating plate.
- The appliance has been used for normal domestic purposes only, and in accordance with the manufacturer's instructions.
- The appliance has not been serviced, maintained, repaired, taken apart or tampered with by any person not authorised by us.
- All service work under this guarantee must be undertaken by a Service Force Centre.
- Any appliance or defective part replaced shall become the Company's property.
- This guarantee is in addition to your statutory and other legal rights.

Home visits are made between **8.30am** and **5.30am** Monday to Friday. Visits may be available outside these hours in which case a **premium** will be charged.

Exclusions

This guarantee does not cover:

- Damage or calls resulting from transportation, improper use or neglect, the replacement of any light bulbs or removable parts of glass or plastic.
- Costs incurred for calls to put right an appliance which is improperly installed or calls to appliances outside the United Kingdom.
- Appliances found to be in use within a commercial environment, plus those which are subject to rental agreements.
- Products of Zanussi manufacture which are not marketed by Zanussi.

European Guarantee

If you should move to another country within Europe then your guarantee moves with you to your new home subject to the following qualifications:

- The guarantee starts from the date you first purchased your product.
- The guarantee is for the same period and to the same extent for labour and parts as exists in the new country of use for this brand or range of products.
- This guarantee relates to you and cannot be transferred to another user.
- Your new home is within the European Community (EC) or European Free Trade Area.
- The product is installed and used in accordance with our instructions and is only used domestically, i.e. a normal household.
- The product is installed taking into account regulations in your new country.

Before you move please contact your nearest Customer Care centre, listed below, to give them details of your new home. They will then ensure that the local Service Organisation is aware of your move and able to look after you and your appliances.

France	Senlis	+33 (0) 3 44 62 29 29
Germany	Nürnberg	+49 (0) 800 234 7378
Italy	Pordernone	+39 (0) 0434 39 4700
Sweden	Stockholm	+46 (0) 8 672 53 90
UK	Slough	+44 (0) 1753 219897

NOTES

IMPORTANT NOTICE

In line with our continuing policy of research and development, we reserve the right to alter models and specifications without prior notice.

This instruction booklet is accurate at the date of printing, but will be superseded if specifications or appearance are changed.

ZANUSSI
55 – 77 HIGH STREET,
SLOUGH,
BERKSHIRE,
SL1 1DZ
TELEPHONE 0870 5 727727
www.zanussi.co.uk

Part Number: 311610302

© Electrolux Household Appliances Limited 2002

 **From the Electrolux Group.** *The world's No.1 choice.*

The Electrolux Group is the world's largest producer of powered appliances for kitchen, cleaning and outdoor use. More than 55 million Electrolux Group products (such as refrigerators, cookers, washing machines, vacuum cleaners, chain saws and lawn mowers) are sold each year to a value of approx. USD 14 billion in more than 150 countries around the world.